

# Ball Valves, Standard Series

This range of valves with **fluoropolymer seals**, available in compact, standard and lockable series, covers many **industrial applications** for which the fluids conveyed and working temperatures require this seal material.

## Product Advantages

**Optimised Installation**

- Full fluid flow
- Long or butterfly lever
- Corrosion resistance
- A lockable version for operational safety
- Good value/performance ratio

**Wide Compatibility**

- Numerous compatible fluids
- Can be used for low and medium pressure applications
- Surface treatment for corrosion protection



**Applications**

- Machine Tool
- Agricultural Machinery
- Textile
- Pneumatics
- Plumbing
- Air Conditioning
- Heating

## Technical Characteristics

Model	Standard and Lockable Series	Compact Series
<b>Compatible Fluids</b>	Compressed air, gas, water, water vapour, oil and all fluids compatible with the component materials	
<b>Working Pressure</b>	0 to 30 bar	0 to 35 bar
<b>Working Temperature</b>	-20°C to +130°C	-10°C to +90°C

Reliable performance is dependent upon the type of fluid conveyed.

### Component Materials

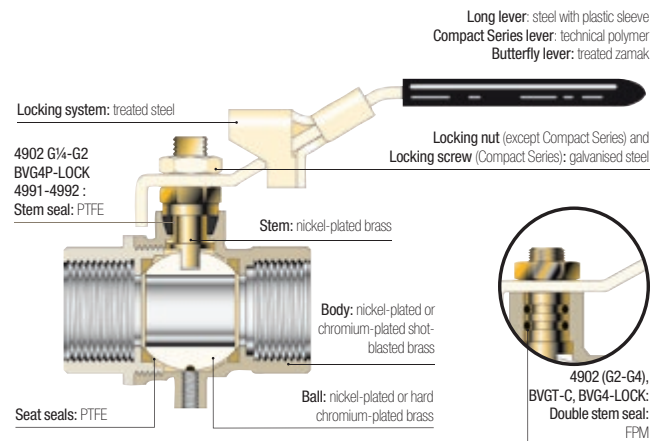

### Silicone-free

### Regulations

**Industrial**

DI: 97/23/EC (module PED A - EC diameters greater than 25 mm)

DI: Machinery Directive 2006/42/EC

DI: 2002/95/EC (RoHS)

RG: 1907/2006 (REACH)

DI: 89/392/EC

**ARA**®

**PNEUMATIK**

53-012 Wrocław tel. 71 364 72 82  
 ul. Wyciągowa 38 fax 71 364 72 83

www.arapneumatik.pl



# Standard Series

## 4902

### 2/2 Standard In-Line Ball Valve, Female BSPP Thread



Nickel-plated brass, PTFE

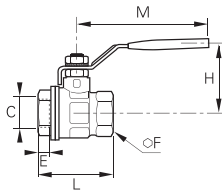

DN	C		E	F	H	L	M	Kg
10	G1/4	<a href="#">4902 10 13</a>	11	20	43	51.5	98	0.154
	G3/8	<a href="#">4902 10 17</a>	11	20	43	51.5	98	0.138
15	G1/2	<a href="#">4902 15 21</a>	13.5	25	47	55	98	0.204
20	G3/4	<a href="#">4902 20 27</a>	12.5	31	58	57.5	122	0.322
25	G1	<a href="#">4902 25 34</a>	15	38	60	69.5	122	0.468
32	G1 1/4	<a href="#">4902 32 42*</a>	17	48	77	81.5	153	0.794
40	G1 1/2	<a href="#">4902 40 49*</a>	18	54	83	95	153	1.082
50	G2	<a href="#">4902 50 48*</a>	22	66	95	113	162	1.787
65	G2 1/2	<a href="#">4902 65 47*</a>	22	85	132	136	255	4.500
80	G3	<a href="#">4902 80 46*</a>	25	99	140	157	255	5.840
100	G4	<a href="#">4902 01 45*</a>	29	125	154	191	255	9.040

\*Models with EC marking

Model from 2 1/2": double stem seal in FPM

Working temperature: -40°C to +170°C (en pointe)

## 4991

### 2/2 Standard Compact In-Line Ball Valve, Male/Female BSPP Thread

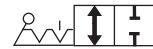

Chromium-plated brass, PTFE

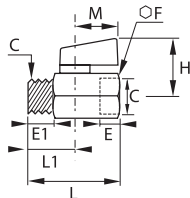

DN	C		E	E1	F	H	L	L1	M	Kg
6	G1/8	<a href="#">4991 00 10</a>	10	10	21	30	41.5	10	24	0.089
	G1/4	<a href="#">4991 00 13</a>	11	11	21	30	41.5	11	24	0.082
8	G3/8	<a href="#">4991 00 17</a>	11	11	21	30	41.5	10.5	24	0.087
	G1/2	<a href="#">4991 00 21</a>	13	13	25	32	49	12.5	24	0.134

## 4992

### 2/2 Standard Compact In-Line Ball Valve, Female BSPP Thread

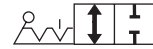

Chromium-plated brass, PTFE

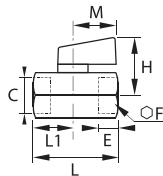

DN	C		E	F	H	L	L1	M	Kg
6	G1/8	<a href="#">4992 00 10</a>	10	21	30	41.5	10	24	0.110
	G1/4	<a href="#">4992 00 13</a>	11	21	30	41.5	11	24	0.106
8	G3/8	<a href="#">4992 00 17</a>	11	21	30	41.5	10.5	24	0.094
	G1/2	<a href="#">4992 00 21</a>	13	25	32	49	12.5	24	0.142

## BVGT4-C

### 2/2 Standard In-Line Ball Valve, Female BSPP Thread



Nickel-plated brass

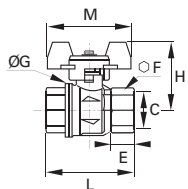

DN	C		E	F	G	H	L	M	Kg
8	G1/4	<a href="#">BVGT4-1/4C</a>	9	20	25	40	39	50	0.130
10	G3/8	<a href="#">BVGT4-3/8C</a>	9	20	25	40	39	50	0.120
15	G1/2	<a href="#">BVGT4-1/2C</a>	11	25	32.5	44	50	50	0.180
20	G3/4	<a href="#">BVGT4-3/4C</a>	12	31	39	49	54	50	0.265
25	G1	<a href="#">BVGT4-1C</a>	14	38	47.5	53	67	50	0.390

Compact lever