

aerospace  
climate control  
**electromechanical**  
filtration  
fluid & gas handling  
hydraulics  
pneumatics  
process control  
sealing & shielding

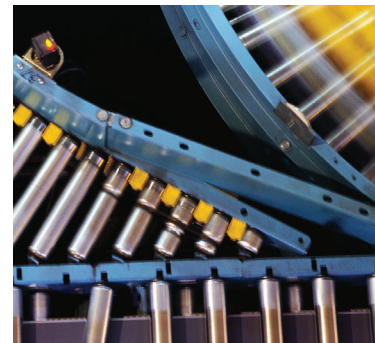

## AC10 Variable Speed Drive

IP20 & IP66 Compact Drive for Simple, Reliable Motor Control in General Purpose Applications



ENGINEERING YOUR SUCCESS.

**ARA**<sup>®</sup>

PNEUMATIK

ul. Wyścigowa 38, 53-012 Wrocław  
tel. 71 364 72 82, ara@arapneumatik.pl

[www.arapneumatik.pl](http://www.arapneumatik.pl)





**WARNING – USER RESPONSIBILITY**

**FAILURE OR IMPROPER SELECTION OR IMPROPER USE OF THE PRODUCTS DESCRIBED HEREIN OR RELATED ITEMS CAN CAUSE DEATH, PERSONAL INJURY AND PROPERTY DAMAGE.**

- This document and other information from Parker-Hannifin Corporation, its subsidiaries and authorized distributors provide product or system options for further investigation by users having technical expertise.
- The user, through its own analysis and testing, is solely responsible for making the final selection of the system and components and assuring that all performance, endurance, maintenance, safety and warning requirements of the application are met. The user must analyze all aspects of the application, follow applicable industry standards, and follow the information concerning the product in the current product catalog and in any other materials provided from Parker or its subsidiaries or authorized distributors.
- To the extent that Parker or its subsidiaries or authorized distributors provide component or system options based upon data or specifications provided by the user, the user is responsible for determining that such data and specifications are suitable and sufficient for all applications and reasonably foreseeable uses of the components or systems.

Variable Speed Drive - AC10 Series

**Overview ..... 5**

**Technical Characteristics..... 11**

- Power Ratings IP20..... 11
- Power Ratings IP66..... 12
- Power Ratings IP66..... 12
- Electrical Characteristics ..... 13
- Environmental Characteristics ..... 13
- Standards and Compliance..... 13
- Dimensions IP20 ..... 14
- Dimensions IP66 ..... 15
- Connections ..... 16

**Software ..... 17**

- Parker Drive System Explorer (DSE) Lite - ..... 17
- Parker Drive Basic (PDB)..... 17

**Accessories and Options ..... 18**

- IP20 Remote Mounting Keypad..... 18
- IP66 Remote Mounting Keypad..... 18
- Clone Module ..... 18
- Braking Resistor ..... 19
- Output Choke ..... 21
- EMC Filter ..... 21

**Order Code..... 22**

- AC10 IP20 Order Codes..... 22
- AC10 IP66 Order Codes..... 23

# Parker Hannifin

## The global leader in motion and control technologies

### Global Product Design

Parker Hannifin has more than 40 years experience in the design and manufacturing of drives, controls, motors and mechanical products. With dedicated global product development teams, Parker draws on industry-leading technological leadership and experience from engineering teams in Europe, North America and Asia.

### Local Application Expertise

Parker has local engineering resources committed to adapting and applying our current products and technologies to best fit our customers' needs.

### Manufacturing to Meet Our Customers' Needs

Parker is committed to meeting the increasing service demands that our customers require to succeed in the global industrial market. Parker's manufacturing teams seek continuous improvement through the implementation of lean manufacturing methods throughout the process. We measure ourselves on meeting our customers' expectations of quality and delivery, not just our own. In order to meet these expectations, Parker operates and continues to invest in our manufacturing facilities in Europe, North America and Asia.

### Electromechanical Worldwide Manufacturing Locations

#### Europe

Littlehampton, United Kingdom  
Dijon, France  
Offenburg, Germany  
Filderstadt, Germany  
Milan, Italy

#### Asia

Wuxi, China  
Chennai, India

#### North America

Rohnert Park, California  
Irwin, Pennsylvania  
Charlotte, North Carolina  
New Ulm, Minnesota



Offenburg, Germany

### Local Manufacturing and Support in Europe

Parker provides sales assistance and local technical support through a network of dedicated sales teams and authorized technical distributors throughout Europe.

For contact information, please refer to the Sales Offices on the back cover of this document or visit [www.parker.com](http://www.parker.com)



Milan, Italy



Littlehampton, UK



Filderstadt, Germany



Dijon, France

# Variable Speed Drive - AC10 Series

## Overview

### Description

The AC10 Compact Drive is a simple, reliable and economical solution to every-day motor control applications requiring speed or torque control within the power range of 0.2 kW to 180 kW for IP20 and 0.4 kW to 90 kW for IP66. Having compact dimensions and features normally only associated with higher specification drives, including, sensorless vector mode for control of Permanent Magnet (PMAC) and AC induction motors, output frequency up to 590 Hz, 1 phase 400 V supplies in all 11 frame sizes and a full 150 % overload at 0.5 Hz for 1 minute, AC10 provides an optimised solution for OEM machine builders looking for a compact, cost-effective drive without compromising on performance.

### Features

#### Simplicity

AC10 is designed to reduce the time and effort required to install, setup and commission through its easy to use integrated keypad. Minimal wiring requirements and two easily accessed terminal rails make AC10 fast and simple to install, having you up and running in no time at all. Auto-tuning sensorless vector mode takes AC10 beyond simple V/Hz control allowing users requiring greater dynamic speed or torque control for their application to benefit from the drives enhanced 0.5 % speed and 5 % torque accuracy.

#### Reliability

Proven technology and manufacturing techniques ensure AC10 has been engineered and built to deliver consistently outstanding levels of performance day in, day out ensuring maximum uptime and productivity. Thanks to its conformally coated PCBs, AC10 is able to withstand even the most arduous class 3C3 environment which many other drives in this class would struggle with, allowing you to operate AC10 with the utmost confidence in more applications.



### Technical Characteristics IP20 - Overview

<b>Power Supply</b>	220 ... 240 VAC ±15 % Single Phase 220 ... 240 VAC ±15 % Three Phase 380 ... 480 VAC +10 % -15 % Three Phase
<b>Input Frequency</b>	50/60 Hz
<b>Power Range</b>	0.2...180 kW
<b>Operating Temperature</b>	-10...50 °C (derate above 40 °C)
<b>Analogue Inputs</b>	1x (0-10V), 1x (0-10V, 0-5V, 0-20mA, 4-20mA)
<b>Analogue Outputs</b>	1x (0-10 V, 0-20 mA)
<b>Digital Inputs</b>	5x 24 VDC frames 1-5, 8x 24 VDC frames 6-11
<b>Digital Outputs</b>	1x 24 VDC frames 1-5 2x 24 VDC frames 6-11
<b>Relay Output</b>	1x 5 A @230 VAC



### Technical Characteristics IP66 - Overview

<b>Power Supply</b>	220 ... 240 VAC ±15 % Single Phase 220 ... 240 VAC ±15 % Three Phase 380 ... 480 VAC +10 % -15 % Three Phase
<b>Input Frequency</b>	50/60 Hz
<b>Power Range</b>	0.4...90 kW
<b>Operating Temperature</b>	-10...50 °C
<b>Analogue Inputs</b>	1x (0-10V), 1x (0-10V, 0-5V, 0-20mA, 4-20mA)
<b>Analogue Outputs</b>	1x (0-10 V, 0-20 mA)
<b>Digital Inputs</b>	6x 24 VDC
<b>Digital Outputs</b>	1x 24 VDC
<b>Relay Output</b>	1x 5 A @230 VAC

# AC10 IP20

The AC10 Compact Drive is a simple, reliable and economical solution to every-day motor control applications in the power range 0.2 kW to 180 kW.

## IE2 Efficiency MR Series AC Induction Motors

An ideal complement to AC10, the MR Series AC Induction motors are IE2 efficient and start from a power range of 0.09 kW. Featuring optional axial in-line force ventilation fan and holding brake, the MR motor is a high quality durable AC motor which when matched to the AC10 will provide you with a complete motor/drive package that will deliver optimal performance in your application.

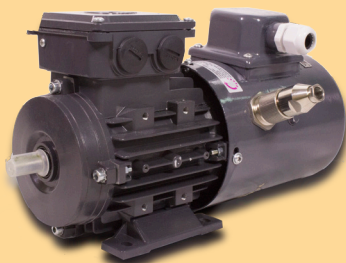

## AC10 Software

DSE Lite, the software package for AC10 series is easy to use, with straightforward block programming and an intuitive user interface.

It is available free of charge.



### Flexible I/O

- Freely assignable digital inputs and outputs, and relay output to suit your application needs
- Analogue inputs & outputs for connection to speed potentiometers and panel meters
- Internal dynamic brake switch as standard



### Modbus/RS485 communication

- Connection to Parker PDB drive setup and monitoring tool
- Connection to PLC or other Modbus RTU / RS485 network
- Clone module connection



### Extra power when it's needed

- 150 % overload for 60 seconds at 0.5 Hz, 200 % for 2 seconds to provide extra starting torque for shifting high inertia loads
- Output power can be uprated for operation in lower ambient temperatures

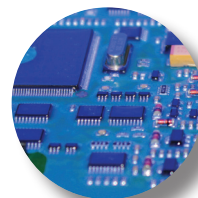

### Suited to all environments

- Optional Internal EMC filter allows use in C3 industrial environments
- Conformal coating provides protection in arduous class 3C3 environments
- Global availability and support
- 50 °C operating temperature
- Fan-cooled heatsink, convection cooled electronics

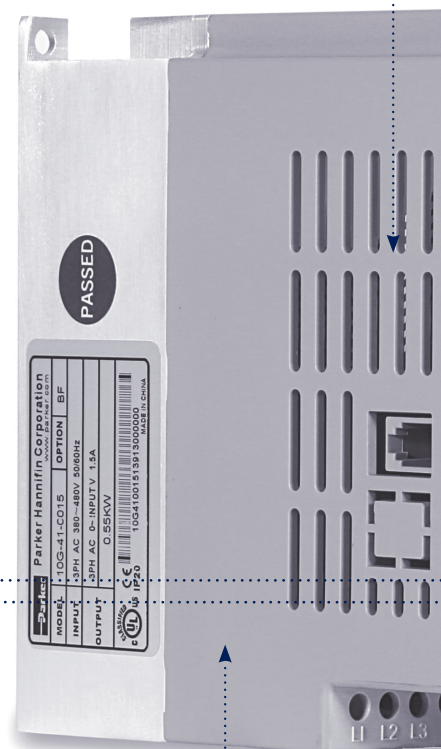



### Simple or enhanced performance

- Simple V/Hz control for general energy saving applications
- Enhanced auto-tuning sensorless vector control providing higher dynamic performance for applications requiring greater speed or torque accuracy
- Sensorless PMAC & AC Induction Motor control



### All at the touch of a button

- Standard ergonomic keypad providing full access to all drive functions
- 4 LEDs provide instant indication of drive status
- Remote mountable keypad option for ease of setup and operation



BASIC SPEED CONTROL

### Simplified Setup

- Simple out of the box operation thanks to integrated macros and quick start guide
- Basic speed control
- Speed preset
- Raise / Lower
- Auto / Man
- PID control
- Essential services (Fire Mode)
- Catch a spinning load (Fly-Catching)

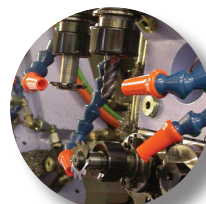

### High Speed Operation

- Up to 590 Hz output for high speed operations such as spindles, centrifuges, mixers etc.

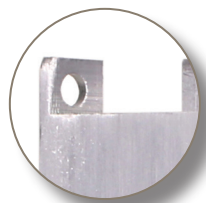

### Compact Dimensions

- When compared to other compact drives of similar functionality, AC10 is noticeably more compact reducing cabinet space and freeing up valuable floor space.

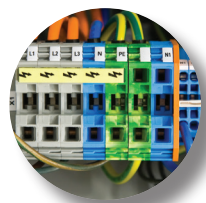

### Choice of operating voltages

- 230 V single phase input up to 2.2 kW
- 230 V three phase input up to 15 kW
- 400 V three phase input from 0.2 kW through to 180 kW
- Internal DC link choke from 30 kW removing the need for external line reactor



### Control at your fingertips

AC10 comes complete with an ergonomic operator keypad as standard featuring 4 LED drive status indicators, a 4 digit 7 segment LED display and a tactile membrane style keypad.

In addition to displaying status and running information, the LED display is also used to access drive configuration parameters which can be quickly and easily changed via the keypad. The keypad can also be used to take local control of the motor to start, stop, increase or decrease motor speed.

An optional keypad is also available and can be mounted remotely from the drive.

### Sensorless Permanent Magnet (PMAC) Motor Control

AC10 is capable of providing control of any sensorless PMAC motor, such as the Parker NX series. Servo motor technology can deliver up to 10 % more energy savings than conventional induction motors and can also be up to 75 % smaller in size.

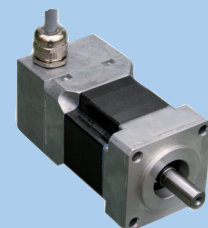

# AC10 IP66

IP66 / NEMA 4x apply to IEC standard 60529-2004 and assess the capability of an enclosure to resist specific environmental conditions. Parker AC10 IP66 offers all the great benefits of the AC10 series drives but with added environmental protection, validated by the IEC, to allow operation in difficult conditions.



## Applications

AC10 IP66 provides a no-fuss approach to general purpose industrial motor control applications across a wide range of industries.

The IP66 enclosure enables use in both indoor and outdoor applications where environmental conditions may be a concern, such as wash-down areas in food and beverage facilities and use in waste plants or rooftop units.

For outdoor applications the drive should be installed under a suitable cover to provide protection against potential damage caused by direct exposure to sun, ice and snow.

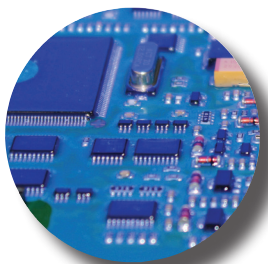

### Suited to all environments

- Robust IP66 rated enclosure for environmental protection
- Optional Internal EMC filter allows use in C3 industrial environments
- Conformal coating provides protection in arduous class 3C3 environments
- 50 °C operating temperature

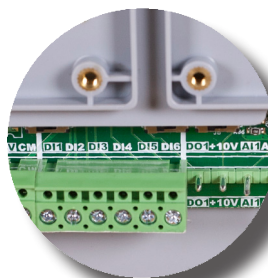

### Flexible Connections

- Freely assignable digital inputs and outputs, and relay output to suit your application needs
- Internal dynamic brake switch as standard
- Connection to PLC or other Modbus RTU / RS485 network
- Clone module connection

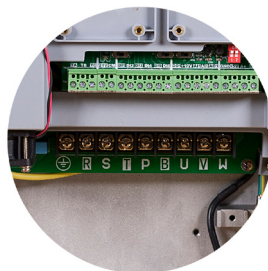

### Easy Connection Access

- Easy user access to connections with removable gland plate



### Extra power when

- 150 % overload for 0.5 Hz, 200 % at 2 Hz extra starting torque for inertia loads
- Output power can be maintained in lower speed operation





### When it's needed

60 seconds at  
seconds to provide  
e for shifting high

be updated for  
ambient temperatures



### All at the touch of a button

- Standard ergonomic keypad providing full access to all drive functions
- Simple out of the box operation thanks to integrated macros and quick start guide

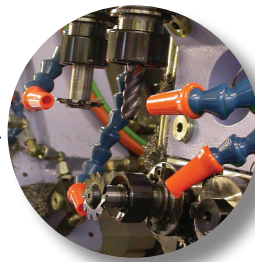

### High Speed Operation

- Up to 590 Hz output for high speed operations such as spindles, centrifuges, mixers etc.

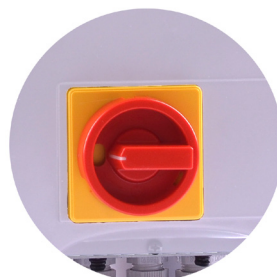

### Customisation Options

- User customisable option panel for:
  - Isolators
  - Switches
  - Push buttons
  - Indicators

## Energy savings made simple

For applications such as fan control, energy savings of up to 50% can be achieved by using the AC10 IP66 to match the motor speed to process requirements.

In addition to saving energy, power factor can be improved, system noise reduced, maintenance periods extended and overall service life increased.

AC10 IP66 can be integrated close to the motor, regardless of the environmental conditions, saving in cabling costs, space and energy as well as the cost of separate cabinets.

Dependent upon the application, payback time can be as little as a few months.

## Decentralisation

AC10 IP66 enables the decentralised drive system where the drives should be installed as close as possible to the motor it is running. Savings can be achieved through reductions in cable installation times as well as the cost of the cabling itself.

Because the drive is self-enclosed no cabinets are required to hold them, saving space and money. Self-enclosure also means that heat output from the drives does not need to be ventilated from the cabinet, leading to a system which is simpler and easier to maintain.

### AC10 Software

DSE Lite, the software package for AC10 series, is easy to use, with straightforward block programming and an intuitive user interface.

It is available free of charge.

## Applications

AC10 provides a no-fuss approach to general purpose industrial motor control applications across a wide range of industries, giving users the benefits of the inherent energy-saving properties of using a variable speed drive, as well as the improved reliability and extended service life benefits associated with smoother starting and stopping of regularly cycling loads.

### Typical applications for AC10 include...

- Conveyor
- Centrifuge
- Fans
- Mixers
- Packaging Machines
- Textile Machines
- Strapping Machines
- Labelling Machines
- Industrial Washing Machines
- Machine Tool Spindles
- Roller Doors



Conveyors

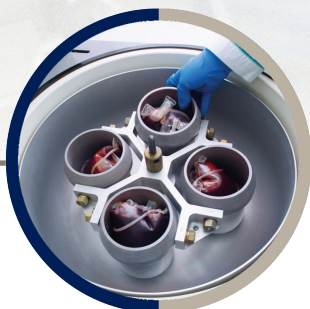

Centrifuges



Fans



Mixers

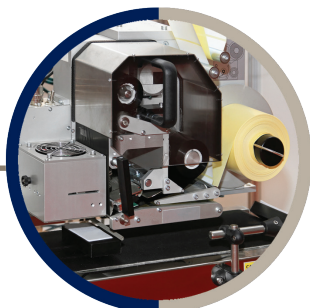

Packaging Machines

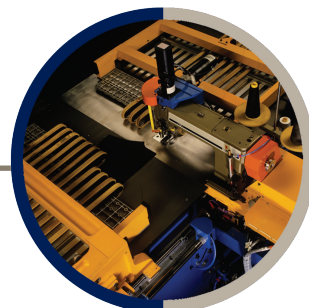

Textile Machines

# Technical Characteristics

## Power Ratings IP20

230 V Single Phase Input		
Nominal Power [kW]	Output Current [A]	Frame Size
0.2	1.5	1
0.4	2.5	1
0.55	3.5	1
0.75	4.5	1
1.1	5	2
1.5	7	2
2.2	10	2

230 V Three phase Input		
Nominal Power [kW]	Output Current [A]	Frame Size
0.2	1.5	1
0.4	2.5	1
0.55	3.5	1
0.75	4.5	1
1.1	5	2
1.5	7	2
2.2	10	2
4	17	3
5.5	21	4
7.5	30	5
11	40	5
15	55	6

400 V Three phase Input		
Nominal Power [kW]	Output Current [A]	Frame Size
0.2	0.6	1
0.4	1	1
0.55	1.5	1
0.75	2	1
1.1	3	2
1.5	4	2
2.2	6.5	2
3	8	3
4	9	3
5.5	12	3
7.5	17	4
11	23	4
15	32	5
18.5	38	5
22	44	5
30	60	6
37	75	7
45	90	7
55	110	8
75	150	8
90	180	9
110	220	9
132	265	10
160	320	11
180	360	11

### Power Ratings IP66

230 V Single Phase Input		
Nominal Power [kW]	Output Current [A]	Frame Size
0.4	2.5	1
0.75	4.5	1
1.5	7	1
2.2	10	1

### Power Ratings IP66

230 V Three phase Input		
Nominal Power [kW]	Output Current [A]	Frame Size
0.4	2.5	1
0.75	4.5	1
1.5	7	1
2.2	10	1

400 V Three phase Input		
Nominal Power [kW]	Output Current [A]	Frame Size
0.75	2	1
1.5	4	1
2.2	6.5	1
3	8	1
4	9	1
5.5	12	2
7.5	17	2
11	23	3
15	32	3
18.5	38	4
22	44	4
30	60	4
37	75	5
45	90	5
55	110	5
75	150	6
90	180	6

## Electrical Characteristics

<b>Power Supply</b>	220 ... 240 VAC $\pm 15$ % Single Phase 220 ... 240 VAC $\pm 15$ % Three Phase 380 ... 480 VAC +10 % -15 % Three Phase
<b>Rated Input Frequency</b>	50/60 Hz
<b>Maximum Switching Frequency</b>	10 kHz
<b>Overload</b>	150% of Rated Current for 60s, 200% for 2s
<b>Output Frequency</b>	0.5...590 Hz
<b>Switching Frequency</b>	2...10kHz selectable
<b>Control Mode</b>	Volts/Hertz or Sensorless Vector (SLV) Mode
<b>Earth Leakage Current</b>	>10 mA (all models)

## Environmental Characteristics

<b>Temperature range</b>	Operating Temperature: -10...+50 °C (derate above 40 °C, IP20 only)
<b>Humidity</b>	Operating humidity: Below 90 % Relative Humidity, non-condensing
<b>Vibration</b>	Below 0.5 g
<b>Altitude</b>	1000 m ASL
<b>Protection Degree</b>	IP20 & IP66
<b>Chemically Active Substances</b>	For the standard product, compliance with EN60271-3-3 is Class 3C3

## Standards and Compliance

<b>Europe (Full CE Marking)</b>	This product conforms with the Low Voltage Directive 2006/95/EC and Electro-Magnet Compatibility Directive 2004/108/EC.  Compliant with European Standards EN 61800-5-1:2007 and EN 61800-3:2004+A1:2012 "Adjustable speed electrical power drive systems"
<b>North America (UL)</b>	Complies with the NEC NFPA 70, Underwriters Laboratories (UL) Listed to UL508C (IP20 up to 180 kW, IP66 up to 15 kW)
<b>Canada (ULC)</b>	Complies with the Canadian Electrical Code, Underwriters Laboratories (UL) Listed to CSA 22.2 No. 14 (IP20 up to 180 kW, IP66 up to 15 kW)

### Dimensions IP20

AC10				
Frame	Height (H)	Width (W)	Depth (D)	Weight [kg]
1	138	80	135	1.25
2	180	106	150	1.76
3	235	138	152	2.96
4	265	156	170	4.9
5	340	205	196	7.5
6	435	266	240	17
7	480	315	240	25
8	555	360	265	40
9	630	411	306	55
10	765	516	326	94
11	910	556	342	120

Dimensions [mm]

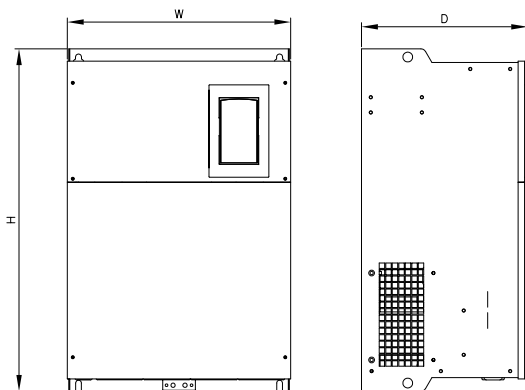
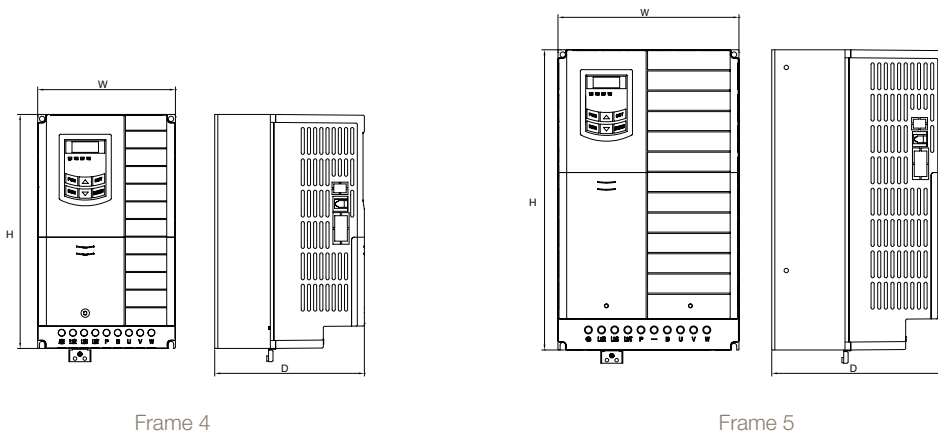
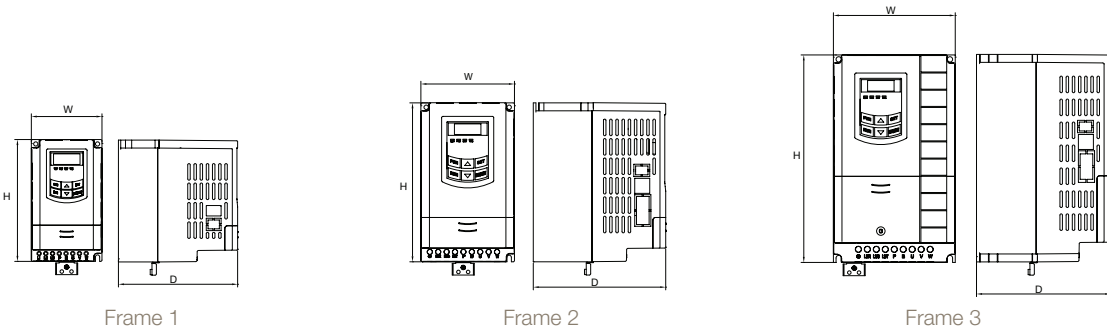

## Dimensions IP66

Frame	Height (H)	Width (W)	Depth (D)	Weight [kg]
1	412	200	198	8
2	418	242	198	10
3	471	242	228	13
4	650	242	323.5	28
5	680	308	378.5	39
6	770	370	403.5	67

Dimensions [mm]

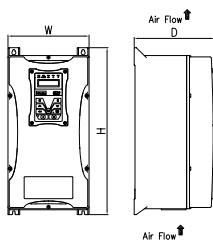

Frame 1

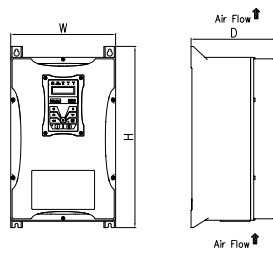

Frame 2

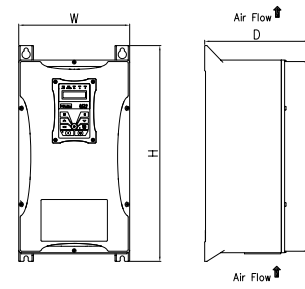

Frame 3

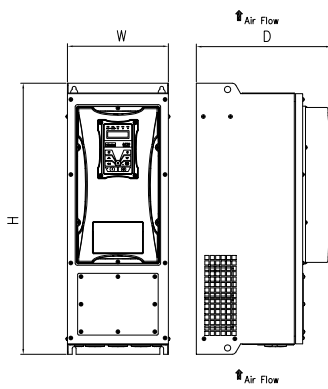

Frame 4

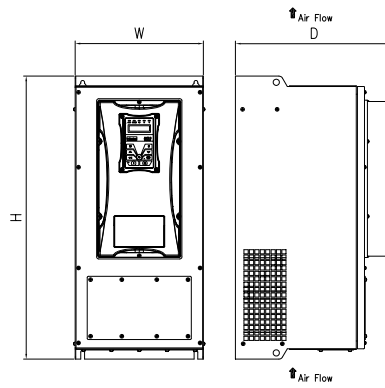

Frame 5

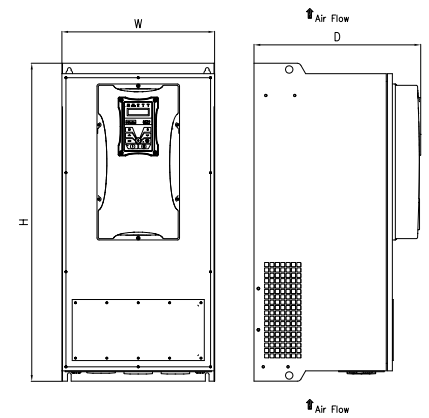

Frame 6

## Connections

Terminal	Description
L1/R	Single or three phase input L1
L2/S	Single or three phase input L2
L3/T	Three phase input L3
P	Braking Resistor
B	Braking Resistor
U	Motor Output 1/U
V	Motor Output 2/V
W	Motor Output 3/W

- Analogue Input 1: (0-10V)
- Analogue Input 2: (0-10V, 0-5V, 0-20mA, 4-20mA)
- Analogue Outputs: (0-10 V, 0-20 mA)
- Digital Inputs: Nominal 24 VDC
- Digital Outputs: Nominal 24 VDC
- Relay Output 1: Volt free contact, 5 A @230 VAC max.

Terminal	Description
TA	Alarm N/O Relay Contact 5 A 24 VDC
TB	Alarm N/C Relay Contact 5 A 24 VDC
TC	Drive Alarm Common
DO1	Digital Output 1
DO2	Digital Output 2 (Frames 6-11 only)
24V	24 VDC Digital Output (max 50 mA)
CM	0 V DC Common
DI1	Digital Input 1
DI2	Digital Input 2
DI3	Digital Input 3
DI4	Digital Input 4
DI5	Digital Input 5
DI6	Digital Input 6 (IP66 & Frames 6-11 IP20)
DI7	Digital Input 7 (Frames 6-11 IP20 only)
DI8	Digital Input 8 (Frames 6-11 IP20 only)
10V	10 V Reference supply (max 20 mA)
AI1	Analogue input 1
AI2	Analogue input 2
GND	Power Supply 0 V
AO1	Analogue Output 1
AO2	Analogue Output 2 (IP66 & Frames 6-11 IP20)
A+	RS485 Channel A
B-	RS485 Channel B
0V	RS485 Supply
5V	RS485 Supply

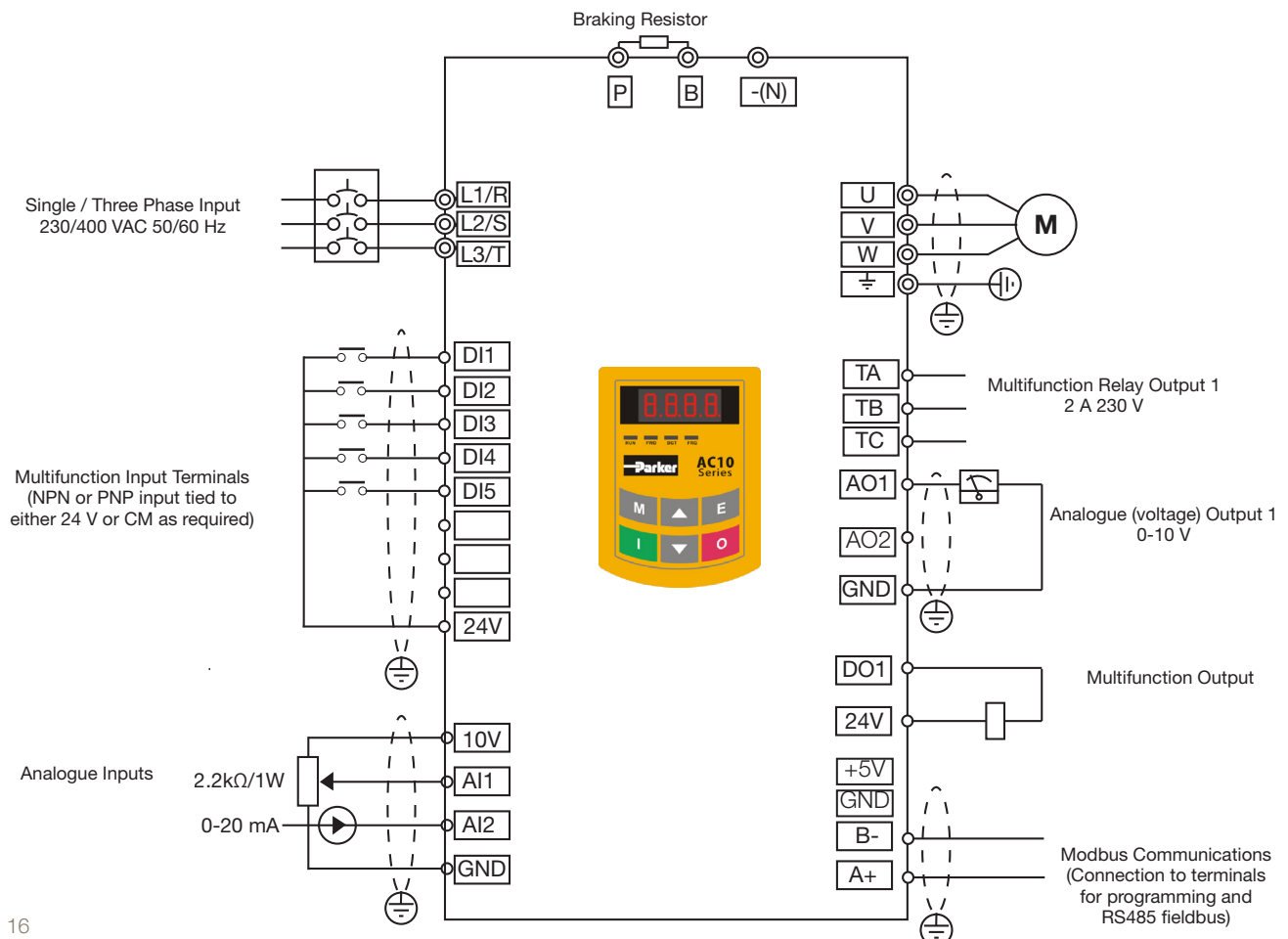



# Software

## Parker Drive System Explorer (DSE) Lite -

Parker drive configuration software Drive System Explorer (DSE) Lite is an easy to use drive configuration software package, designed to make programming your application as simple as possible without compromising on functionality.

DSE Lite is based around a straightforward block programming and an intuitive user interface which supports user-defined configurations and offers real-time monitoring and charting. DSE Lite allows the user to create, parameterise and configure user defined applications as well as parameterise and connect fixed Motor Control blocks.

It is available free of charge to download from [www.parker.com](http://www.parker.com).

**COMING SOON**

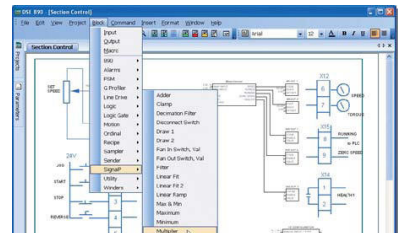
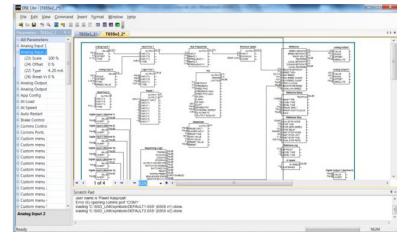

## Parker Drive Basic (PDB)

### Free Configuration and Diagnostic Monitoring Software

Parker Drive Basic is a monitoring and configuration software tool for use with AC10 Variable Speed Drives. Parker Drive Basic is available as a free download from the Parker website.

Connecting to the AC10 over Modbus, Parker Drive Basic enables users to import, modify and export drive parameters as well as providing a convenient means of starting, stopping and monitoring the operation of the drive.

Note: a USB/RS485 adapter is required to enable connection between PC and drive

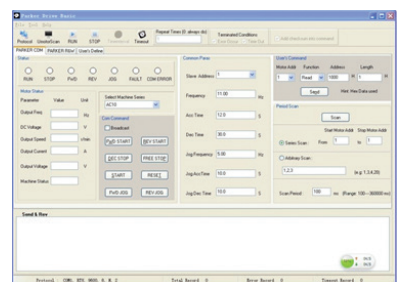
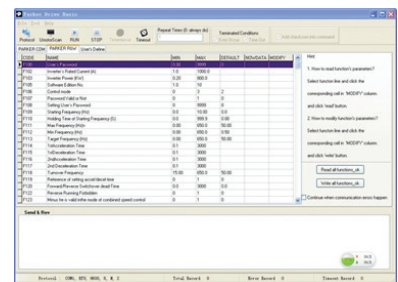

## Accessories and Options

### IP20 Remote Mounting Keypad

The remote mounting keypad (IP20) can be mounted away from the drive, such as on the door of an electrical enclosure, allowing users to configure, operate and monitor the drive without having to access the drive directly. The remote keypad provides an alternative offering the same functionality as the drive mounted keypad but can be connected to the drive via a 1.5 m cable plugged into the port on the left hand side of the drive.

Order Code	Description
1001-00-00	Remote Keypad
1001-01-00	Extension cable (1.5m)



### IP66 Remote Mounting Keypad

The remote mounting keypad (IP66) can be mounted away from the IP66 drive, allowing users to configure, operate and monitor the drive without having to access the drive directly. The remote keypad provides an alternative offering the same functionality as the drive mounted keypad but can be connected to the drive via a 1.5 m cable with IP66 plugs. For use with IP66 drives only.

Order Code	Description
1601-00-00	Remote Keypad
1602-01-00	Extension cable (1.5m)



### Clone Module

AC10 clone module allows users to copy applications between drives and upload / download parameter sets between drives and the PC software.

- Extract parameters from the drive
- Download parameters to a drive
- Connect AC10 to PC
- Copy parameters between drives

Order Code	Description
1002-00-00	Clone Module



## Braking Resistor

During deceleration, or with an over-hauling load, the motor acts as a generator. Energy flows back from the motor into the DC link capacitors within the drive, causing their voltage to rise. If this voltage exceeds a maximum value, the drive will trip to protect the capacitors and internal power devices. The amount of energy that can be absorbed by the capacitors can vary between different applications causing the drive to trip on overvolts. To increase the drive's dynamic braking capability, high power resistor(s), connected across the DC link, allow the dissipation of this excess energy for short term stoppage or braking.



### Brake resistor selection

Brake resistor assemblies must be rated to absorb both peak braking power during deceleration and the average power over the complete cycle.

$$\text{Peak braking power} = \frac{0.0055J \times (n_1^2 - n_2^2)}{t_b} \text{ (W)}$$

$$\text{Average braking power } P_{av} = \frac{P_{pk} \times t_b}{t_c}$$

J: total inertia [kgm<sup>2</sup>]  
n<sub>1</sub>: initial speed [min<sup>-1</sup>]  
n<sub>2</sub>: final speed [min<sup>-1</sup>]  
t<sub>b</sub>: braking time [s]  
t<sub>c</sub>: cycle time [s]

### Resistors above 500 W

Resistors above 500 W are available upon request :







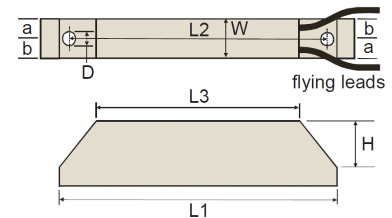









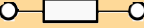



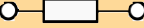

- IP20 protection up to 3 kW
- IP13 protection between 4.2 and 9.8 kW

Model	Resistance [Ω]	Nom. Power [W]	Dimensions [mm]							
			L1	L2	L3	W	H	D	a	b
CZ467715	500	60	100	87	60	22	41	4.3	10	12
CZ467714	200	100	165	152	125	22	41	4.3	10	12
CZ389853	100	100	165	152	125	22	41	4.3	10	12
CZ467717	100	200	165	146	125	30	60	4.3	13	17
CZ463068	56	200	165	146	125	30	60	4.3	13	17
CZ388397	56	200	165	146	125	30	60	4.3	13	17
CZ388396	36	500	335	316	295	30	60	4.3	13	17
CZ467716	28 x 2	500	335	316	295	30	60	4.3	13	17

Overload 5 s: 500 %  
Overload 3 s : 833 %  
Overload 1 s: 2500 %

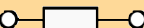
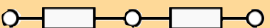
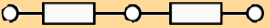

Variable Speed Drive - AC10  
Accessories and Options

Power Rating [kW]	R1 Resistor Order Code	R2 Resistor Order Code	Connected	Minimum resistance [Ω]	Braking Power [W]
<b>230 V Single Phase</b>					
0,2	CZ467717	-		60	150
0,37	CZ467717	-		60	150
0,55	CZ467717	-		60	150
0,75	CZ467717	-		60	150
1,1	CZ467717	-		60	150
1,5	CZ467717	-		60	150
2,2	CZ467717	-		60	150
<b>230 V Three Phase</b>					
0,37	CZ467717	-		60	150
0,55	CZ467717	-		60	150
0,75	CZ467717	-		60	150
1,1	CZ467717	-		60	150
1,5	CZ467717	-		60	150
2,2	CZ467717	-		60	150
<b>400 V Three Phase</b>					
0,2	CZ467715	-		500	80
0,37	CZ467715	-		500	80
0,55	CZ467715	-		500	80
0,75	CZ467714	-		200	80
1,1	CZ467714	-		150	80
1,5	CZ467714	-		150	80
2,2	CZ467714	-		150	150
3	CZ467714	-		150	150
4	CZ467714	-		150	150
5,5	CZ467716	CZ467716		120	250
7,5	CZ388396	CZ388396		120	500
11	CZ467716	CZ467716		90	1000

Note 1: The above resistors are only provided as a guide. Please use our calculation guide to confirm accurate braking resistor requirements.

Note 2: For resistor sizes between 15 kW and 180 kW please contact [ssdedcs@parker.com](mailto:ssdedcs@parker.com)

## Output Choke

To reduce capacitive currents and prevent nuisance tripping in installations with longer cable runs over 100m, a choke may be fitted to the drives output in series with the motor.

Order Code	Motor Power Normal Duty [kW]	Choke Inductance [mH]	Current [ $A_{rms}$ ]
CO055931	1.1	2	7.5
	1.5		
	2.2		
	3.0		
CO057283	4.0	0.9	22
	5.5		
	7.5		
CO057284	11	0.45	33
	15		
CO057285	18	0.3	44
CO055193	22	0.05	70
	30		
CO055253	37	0.05	99
	45		
CO057960	55	0.05	243
CO387886	75	0.05	360



Note 1: For output chokes over 75 kW please contact [ssdedcs@parker.com](mailto:ssdedcs@parker.com)

## EMC Filter

A range of custom designed optional EMC (Electromagnetic Compatibility) filters are available for use with AC10. They are used to help achieve conformance with EMC directive BS EN61800-3.

AC10 can be ordered with an EMC filter fitted that meets the requirements of a class C3 environment. For class C2 or C1 environments, please contact your local sales office.

# Order Code

## AC10 IP20

	1	2		3	4		5		6	7
Order example	10	G	-	1	1	-	0015	-	B	N

<b>1</b>	<b>Device Family</b>	
10	AC10 IP20 Variable Speed Drive	
<b>2</b>	<b>Industry</b>	
G	General Purpose	
<b>3</b>	<b>Voltage</b>	
1	230 V Single Phase	
3	230 V Three Phase	
4	400 V Three Phase	
<b>4&amp;5</b>	<b>Frame Size &amp; Rating</b>	
<b>230 V Supply</b>		
1	0015	0.2 kW
1	0025	0.37 kW
1	0035	0.55 kW
1	0045	0.75 kW
2	0050	1.1 kW
2	0070	1.5 kW
2	0100	2.2 kW
3	0170	4.0 kW
4	0210	5.5 kW
5	0300	7.5 kW
5	0400	11 kW
6	0550	15 kW
<b>400 V Supply</b>		
1	0006	0.2 kW
1	0010	0.37 kW
1	0015	0.55 kW
2	0020	0.75 kW
2	0030	1.1 kW
2	0040	1.5 kW
2	0065	2.2 kW
3	0080	3.0 kW
3	0090	4.0 kW
3	0120	5.5 kW
4	0170	7.5 kW
4	0230	11 kW
5	0320	15 kW
5	0380	18.5 kW
5	0440	22 kW
6	0600	30 kW
7	0750	37 kW
7	0900	45 kW
8	1100	55 kW
8	1500	75 kW
9	1800	90 kW
9	2200	110 kW
10	2650	132 kW
11	3200	160 kW
11	3600	180 kW
<b>6</b>	<b>Braking Module</b>	
B	Braking Module Fitted	
<b>7</b>	<b>EMC Filter</b>	
N	No Filter Fitted	
F	C3 EMC Filter Fitted	

Visit the Parker website to full  
configure the options available for  
AC10, generate the correct product  
code and to find out where to buy.

[www.parker.com/ssd/ac10](http://www.parker.com/ssd/ac10)

## Order Code

### AC10 IP66

	1	2		3	4		5		6	7
Order example	16	G	-	1	1	-	0015	-	B	N

<b>1</b>	<b>Device Family</b>	
16	AC10 IP66 Variable Speed Drive	
<b>2</b>	<b>Industry</b>	
G	General Purpose	
<b>3</b>	<b>Voltage</b>	
1	230 V Single Phase	
3	230 V Three Phase	
4	400 V Three Phase	
<b>4&amp;5</b>	<b>Frame Size &amp; Rating</b>	
<b>230 V Supply</b>		
1	0025	0.4 kW
1	0045	0.75 kW
1	0070	1.5 kW
1	0100	2.2 kW
<b>400 V Supply</b>		
1	0020	0.75 kW
1	0040	1.5 kW
1	0065	2.2 kW
1	0080	3.0 kW
1	0090	4.0 kW
2	0120	5.5 kW
2	0170	7.5 kW
3	0230	11 kW
3	0320	15 kW
4	0380	18.5 kW
4	0440	22 kW
4	0600	30 kW
5	0750	37 kW
5	0900	45 kW
5	1100	55 kW
6	1500	75 kW
6	1800	90 kW
<b>6</b>	<b>Braking Module</b>	
B	Braking Module Fitted	
<b>7</b>	<b>EMC Filter*</b>	
N	No Filter Fitted	
F	C3 EMC Filter Fitted	

\*55 kW, 75 kW and 90 kW IP66 versions come with EMC filter as standard.

Visit the Paker website to full configure the options available for AC10, generate the correct product code and to find out where to buy.

[www.parker.com/ssd/ac10](http://www.parker.com/ssd/ac10)







# Parker's Motion & Control Technologies

At Parker, we're guided by a relentless drive to help our customers become more productive and achieve higher levels of profitability by engineering the best systems for their requirements. It means looking at customer applications from many angles to find new ways to create value. Whatever the motion and control technology need, Parker has the experience, breadth of product and global reach to consistently deliver. No company knows more about motion and control technology than Parker. For further info call 00800 27 27 5374



## Aerospace

### Key Markets

Aftermarket services  
Commercial transports  
Engines  
General & business aviation  
Helicopters  
Launch vehicles  
Military aircraft  
Missiles  
Power generation  
Regional transports  
Unmanned aerial vehicles

### Key Products

Control systems & actuation products  
Engine systems & components  
Fluid conveyance systems & components  
Fluid metering, delivery & atomization devices  
Fuel systems & components  
Fuel tank inerting systems  
Hydraulic systems & components  
Thermal management  
Wheels & brakes



## Climate Control

### Key Markets

Agriculture  
Air conditioning  
Construction Machinery  
Food & beverage  
Industrial machinery  
Life sciences  
Oil & gas  
Precision cooling  
Process  
Refrigeration  
Transportation

### Key Products

Accumulators  
Advanced actuators  
CO<sub>2</sub> controls  
Electronic controllers  
Filter driers  
Hand shut-off valves  
Heat exchangers  
Hose & fittings  
Pressure regulating valves  
Refrigerant distributors  
Safety relief valves  
Smart pumps  
Solenoid valves  
Thermostatic expansion valves



## Electromechanical

### Key Markets

Aerospace  
Factory automation  
Life science & medical  
Machine tools  
Packaging machinery  
Paper machinery  
Plastics machinery & converting  
Primary metals  
Semiconductor & electronics  
Textile  
Wire & cable

### Key Products

AC/DC drives & systems  
Electric actuators, gantry robots & slides  
Electrohydraulic actuation systems  
Electromechanical actuation systems  
Human machine interface  
Linear motors  
Stepper motors, servo motors, drives & controls  
Structural extrusions



## Filtration

### Key Markets

Aerospace  
Food & beverage  
Industrial plant & equipment  
Life sciences  
Marine  
Mobile equipment  
Oil & gas  
Power generation & renewable energy  
Process  
Transportation  
Water Purification

### Key Products

Analytical gas generators  
Compressed air filters & dryers  
Engine air, coolant, fuel & oil filtration systems  
Fluid condition monitoring systems  
Hydraulic & lubrication filters  
Hydrogen, nitrogen & zero air generators  
Instrumentation filters  
Membrane & fiber filters  
Microfiltration  
Sterile air filtration  
Water desalination & purification filters & systems



## Fluid & Gas Handling

### Key Markets

Aerial lift  
Agriculture  
Bulk chemical handling  
Construction machinery  
Food & beverage  
Fuel & gas delivery  
Industrial machinery  
Life sciences  
Marine  
Mining  
Mobile  
Oil & gas  
Renewable energy  
Transportation

### Key Products

Check valves  
Connectors for low pressure fluid conveyance  
Deep sea umbilicals  
Diagnostic equipment  
Hose couplings  
Industrial hose  
Mooring systems & power cables  
PTFE hose & tubing  
Quick couplings  
Rubber & thermoplastic hose  
Tube fittings & adapters  
Tubing & plastic fittings



## Hydraulics

### Key Markets

Aerial lift  
Agriculture  
Alternative energy  
Construction machinery  
Forestry  
Industrial machinery  
Machine tools  
Marine  
Material handling  
Mining  
Oil & gas  
Power generation  
Refuse vehicles  
Renewable energy  
Truck hydraulics  
Turf equipment

### Key Products

Accumulators  
Cartridge valves  
Electrohydraulic actuators  
Human machine interfaces  
Hybrid drives  
Hydraulic cylinders  
Hydraulic motors & pumps  
Hydraulic systems  
Hydraulic valves & controls  
Hydrostatic steering  
Integrated hydraulic circuits  
Power take-offs  
Power units  
Rotary actuators  
Sensors



## Pneumatics

### Key Markets

Aerospace  
Conveyor & material handling  
Factory automation  
Life science & medical  
Machine tools  
Packaging machinery  
Transportation & automotive

### Key Products

Air preparation  
Brass fittings & valves  
Manifolds  
Pneumatic accessories  
Pneumatic actuators & grippers  
Pneumatic valves & controls  
Quick disconnects  
Rotary actuators  
Rubber & thermoplastic hose & couplings  
Structural extrusions  
Thermoplastic tubing & fittings  
Vacuum generators, cups & sensors



## Process Control

### Key Markets

Alternative fuels  
Biopharmaceuticals  
Chemical & refining  
Food & beverage  
Marine & shipbuilding  
Medical & dental  
Microelectronics  
Nuclear Power  
Offshore oil exploration  
Oil & gas  
Pharmaceuticals  
Power generation  
Pulp & paper  
Steel  
Water/wastewater

### Key Products

Analytical Instruments  
Analytical sample conditioning products & systems  
Chemical injection fittings & valves  
Fluoropolymer chemical delivery fittings, valves & pumps  
High purity gas delivery fittings, valves, regulators & digital flow controllers  
Industrial mass flow meters/controllers  
Permanent no-weld tube fittings  
Precision industrial regulators & flow controllers  
Process control double block & bleeds  
Process control fittings, valves, regulators & manifold valves



## Sealing & Shielding

### Key Markets

Aerospace  
Chemical processing  
Consumer  
Fluid power  
General industrial  
Information technology  
Life sciences  
Microelectronics  
Military  
Oil & gas  
Power generation  
Renewable energy  
Telecommunications  
Transportation

### Key Products

Dynamic seals  
Elastomeric o-rings  
Electro-medical instrument design & assembly  
EMI shielding  
Extruded & precision-cut, fabricated elastomeric seals  
High temperature metal seals  
Homogeneous & inserted elastomeric shapes  
Medical device fabrication & assembly  
Metal & plastic retained composite seals  
Shielded optical windows  
Silicone tubing & extrusions  
Thermal management  
Vibration dampening

ENGINEERING YOUR SUCCESS.

# Parker Worldwide

**AE – UAE, Dubai**  
Tel: +971 4 8127100  
parker.me@parker.com

**AR – Argentina, Buenos Aires**  
Tel: +54 3327 44 4129

**AT – Austria, Wiener Neustadt**  
Tel: +43 (0)2622 23501-0  
parker.austria@parker.com

**AT – Eastern Europe, Wiener Neustadt**  
Tel: +43 (0)2622 23501 900  
parker.easteurope@parker.com

**AU – Australia, Castle Hill**  
Tel: +61 (0)2-9634 7777

**AZ – Azerbaijan, Baku**  
Tel: +994 50 2233 458  
parker.azerbaijan@parker.com

**BE/LU – Belgium, Nivelles**  
Tel: +32 (0)67 280 900  
parker.belgium@parker.com

**BR – Brazil, Cachoeirinha RS**  
Tel: +55 51 3470 9144

**BY – Belarus, Minsk**  
Tel: +375 17 209 9399  
parker.belarus@parker.com

**CA – Canada, Milton, Ontario**  
Tel: +1 905 693 3000

**CH – Switzerland, Etoy**  
Tel: +41 (0)21 821 87 00  
parker.switzerland@parker.com

**CL – Chile, Santiago**  
Tel: +56 2 623 1216

**CN – China, Shanghai**  
Tel: +86 21 2899 5000

**CZ – Czech Republic, Klecany**  
Tel: +420 284 083 111  
parker.czechrepublic@parker.com

**DE – Germany, Kaarst**  
Tel: +49 (0)2131 4016 0  
parker.germany@parker.com

**DK – Denmark, Ballerup**  
Tel: +45 43 56 04 00  
parker.denmark@parker.com

**ES – Spain, Madrid**  
Tel: +34 902 330 001  
parker.spain@parker.com

**FI – Finland, Vantaa**  
Tel: +358 (0)20 753 2500  
parker.finland@parker.com

**FR – France, Contamine s/Arve**  
Tel: +33 (0)4 50 25 80 25  
parker.france@parker.com

**GR – Greece, Athens**  
Tel: +30 210 933 6450  
parker.greece@parker.com

**HK – Hong Kong**  
Tel: +852 2428 8008

**HU – Hungary, Budapest**  
Tel: +36 1 220 4155  
parker.hungary@parker.com

**IE – Ireland, Dublin**  
Tel: +353 (0)1 466 6370  
parker.ireland@parker.com

**IN – India, Mumbai**  
Tel: +91 22 6513 7081-85

**IT – Italy, Corsico (MI)**  
Tel: +39 02 45 19 21  
parker.italy@parker.com

**JP – Japan, Tokyo**  
Tel: +81 (0)3 6408 3901

**KR – South Korea, Seoul**  
Tel: +82 2 559 0400

**KZ – Kazakhstan, Almaty**  
Tel: +7 7272 505 800  
parker.easteurope@parker.com

**MX – Mexico, Apodaca**  
Tel: +52 81 8156 6000

**MY – Malaysia, Shah Alam**  
Tel: +60 3 7849 0800

**NL – The Netherlands, Oldenzaal**  
Tel: +31 (0)541 585 000  
parker.nl@parker.com

**NO – Norway, Asker**  
Tel: +47 66 75 34 00  
parker.norway@parker.com

**NZ – New Zealand, Mt Wellington**  
Tel: +64 9 574 1744

**PL – Poland, Warsaw**  
Tel: +48 (0)22 573 24 00  
parker.poland@parker.com

**PT – Portugal, Leca da Palmeira**  
Tel: +351 22 999 7360  
parker.portugal@parker.com

**RO – Romania, Bucharest**  
Tel: +40 21 252 1382  
parker.romania@parker.com

**RU – Russia, Moscow**  
Tel: +7 495 645-2156  
parker.russia@parker.com

**SE – Sweden, Spånga**  
Tel: +46 (0)8 59 79 50 00  
parker.sweden@parker.com

**SG – Singapore**  
Tel: +65 6887 6300

**SK – Slovakia, Banská Bystrica**  
Tel: +421 484 162 252  
parker.slovakia@parker.com

**SL – Slovenia, Novo Mesto**  
Tel: +386 7 337 6650  
parker.slovenia@parker.com

**TH – Thailand, Bangkok**  
Tel: +662 717 8140

**TR – Turkey, Istanbul**  
Tel: +90 216 4997081  
parker.turkey@parker.com

**TW – Taiwan, Taipei**  
Tel: +886 2 2298 8987

**UA – Ukraine, Kiev**  
Tel: +380 44 494 2731  
parker.ukraine@parker.com

**UK – United Kingdom, Warwick**  
Tel: +44 (0)1926 317 878  
parker.uk@parker.com

**US – USA, Cleveland**  
Tel: +1 216 896 3000

**VE – Venezuela, Caracas**  
Tel: +58 212 238 5422

**ZA – South Africa, Kempton Park**  
Tel: +27 (0)11 961 0700  
parker.southafrica@parker.com

192-300027N7 Feb 2016

© 2016 Parker Hannifin Corporation. All rights reserved.

Your local authorized Parker distributor



**Parker Hannifin Ltd.**  
Tachbrook Park Drive  
Tachbrook Park, Warwick CV34 6TU  
United Kingdom  
Tel.: +44 (0) 1926 317 878  
Fax: +44 (0) 1926 317 855  
parker.uk@parker.com  
www.parker.com

**ARA<sup>®</sup>**  
**PNEUMATIK**  
ul. Wyscigowa 38, 53-012 Wrocław  
tel. 71 364 72 82, ara@arapneumatik.pl  
**www.arapneumatik.pl**

