

Characteristics

Characteristics	Symbol	Unit	Description				
General Features							
Description	2/2 Way Valve						
Type	Poppet valve normally closed						
Mounting	Direct in piping						
Tube connection	Thread						
Port size	G1/2	G3/4	G1	G1 1/2	G2		
Weight (mass)	kg	0.745	1.115	1.365	2.695	4.290	
Installation							
In any position							
Ambient temperature range	$T_{min/max}$	°C	-20 to +80	Note: Please consult us for operating temperatures below 0°C			
Medium temperature range	$T_{min/max}$	°C	0 to +80				
Medium	Compressed air, neutral gases, presswater (for low flow- und valve closingspeed only)						
Actuating medium	filtered compressed air						
Pneumatic characteristics							
Nominal pressure	p_n	bar	6.3				
Operating pressure range	$p_{min/max}$	bar	0–10				
Nominal flow	Q_N	l/min	2200	5000	6900	22000	40000
Actuation							
Pneumatic Direct							

2/2 Way Stop Valves Series ARKV

G1/2 to G2

Actuation System:
–Pneumatic

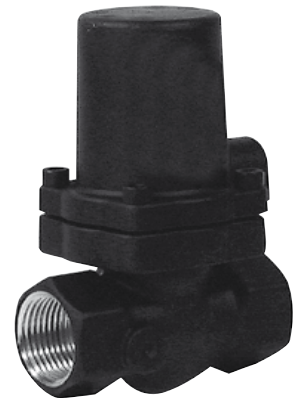

Dimension Table

Dimensions in mm

Type	A	B	C	D	E	F	G	H
ARKV-15 NC	65	G1/2	G1/8	55	61	41.5	95	109.5
ARKV-20 NC	76	G3/4	G1/4	65	75	50	112	129
ARKV-25 NC	91	G1	G1/4	65	75	57	119	139
ARKV-40 NC	123	G1 1/2	G1/4	110	112	67	137	167.5
ARKV-50 NC	150	G2	G1/4	130	134	75	153	190

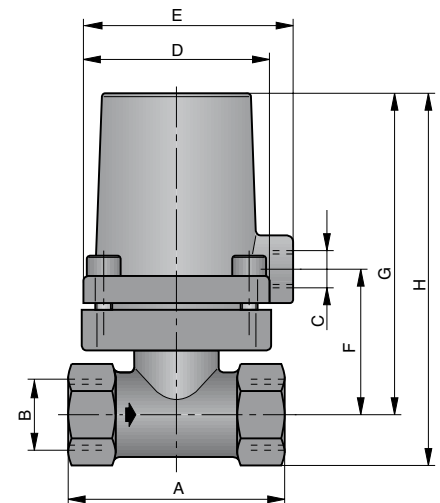

Order Instructions

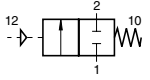
Actuation System	Symbol	Order data	Type	Order No.
Pneumatic		ARKV-15 NC		PD 07334
		ARKV-20 NC		PD 07580
		ARKV-25 NC		PD 07581
		ARKV-40 NC		PD 07757
		ARKV-50 NC		PD 07765

Actuating Pressure $O = p_{st\ min}$ to open $S = p_{st\ max}$ to close

– Type: ARKV-15

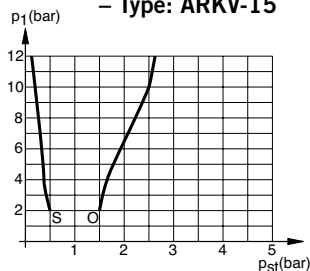

– Type: ARKV-20

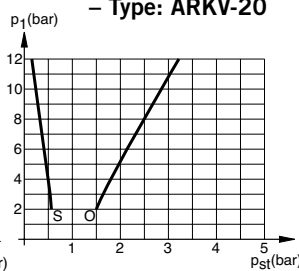

– Type: ARKV-25

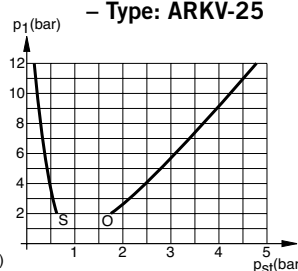

– Type: ARKV-40

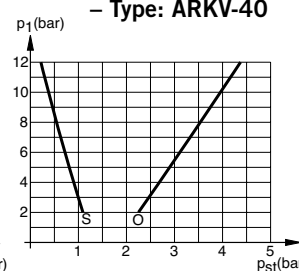

– Type: ARKV-50

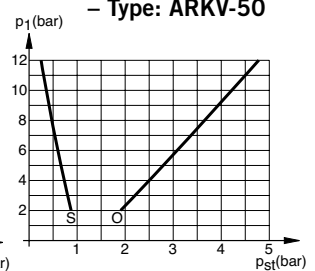

ARA®

PNEUMATIK

53-012 Wrocław tel. 71 364 72 82
ul. Wyścigowa 38 fax 71 364 72 83

www.arapneumatik.pl

