



aerospace
climate control
electromechanical
filtration
fluid & gas handling
hydraulics
pneumatics
process control
sealing & shielding



PVL-B2 Inline valves

Stackable and Stand-alone

PDE2682TCUK



ENGINEERING YOUR SUCCESS.

DYSTRYBUTOR PARKER PREMIUM

ARA[®]
PNEUMATIK

| arapneumatik.pl

PARKER STORE WROCLAW
pneumatyka@arapneumatik.pl
TEL. 71 364 72 80

PARKER STORE KATOWICE
katowice@arapneumatik.pl
TEL. 32 779 76 40





Important !

Before carrying out any service work, ensure that the valve and manifold have been vented. Remove the primary supply air hose to ensure total disconnection of the air supply before dismantling valves or blank connection blocks.



NB !

All technical data in this catalogue is typical only. The air quality is decisive for the valve life: see ISO 8573.



WARNING

FAILURE OR IMPROPER SELECTION OR IMPROPER USE OF THE PRODUCTS AND/OR SYSTEMS DESCRIBED HEREIN OR RELATED ITEMS CAN CAUSE DEATH, PERSONAL INJURY AND PROPERTY DAMAGE.

This document and other information from Parker Hannifin Corporation, its subsidiaries and authorized distributors provide product and/or system options for further investigation by users having technical expertise. It is important that you analyze all aspects of your application and review the information concerning the product or system in the current product catalog. Due to the variety of operating conditions and applications for these products or systems, the user, through its own analysis and testing, is solely responsible for making the final selection of the products and systems and assuring that all performance, safety and warning requirements of the application are met. The products described herein, including without limitation, product features, specifications, designs, availability and pricing, are subject to change by Parker Hannifin Corporation and its subsidiaries at any time without notice.

SALE CONDITIONS

The items described in this document are available for sale by Parker Hannifin Corporation, its subsidiaries or its authorized distributors. Any sale contract entered into by Parker will be governed by the provisions stated in Parker's standard terms and conditions of sale (copy available upon request).

Summary	Page No.
Product Overview	4
Technical characteristics	6
PVL-B22 - Stackable Series - Order Code	8
PVL-B22 Valve – 10 mm pilot solenoid valve	8
PVL-B22 Valve – 15 mm DIN form C pilot solenoid valve	9
Head and Tail set	10
Pneumatic Accessories	10
Spare mounting and assembly kits	10
Assembly instructions	11
PVL-B21 – Stand-alone Series – Order Code	12
PVL-B21 Valve – 10 mm pilot solenoid valve	12
PVL-B21 Valve – 15 mm DIN form C pilot solenoid valve	13
Pneumatic Accessories	14
10 mm pilot solenoid valve and connectors	14
15 mm DIN form C pilot solenoid valve and connectors	15
Dimensions	16

PVL-B2 Valve Range

18mm width

10mm 24 Vdc Pilot Valve

Economic electrical connection (IP40)



15mm Pilot Valve

Standard DIN form C electrical connection (IP65)



10mm Pilot Valve

Series Overview

15mm Pilot Valve



PVL-B21 : Stand- alone Series – Traditional wiring

Very useful to control isolated cylinders, these stand-alone valve Series are compact and easy to mount on the machines close to the actuator with neat electrical pilot. Available with either 15 or 10 mm pilot solenoid valve traditional wiring, these Series can also be stacked and mixed into a stacking valve island Series



PVL-B22 : Stackable Series – Traditional wiring

The PVL-B2 Series stacking system permits assembly of several valves into one stack. Supply is connected at either a single or a dual head/tail set. Two common exhaust galleries are provided. Connections to outlet ports 2 and 4 on each valve can be accomplished by G1/8" threaded pipe or instant tube fittings, 6 or 8 mm OD. Electrical connection is made to each solenoid using either a 15 mm - 3 pin - 8 mm spacing DIN Form C connector plug or Clip Connector. Each stack assembly can handle any combination of single or double solenoid valves



Compatibility with original PVL-B & PVL-C Series

Issued from the original PVL-B Series, the new PVL-B2 Series can be associated in one configuration mixing PVL-B & PVL-C Valves. For further details on the PVL-B & PVL-C Series, you can refer to the dedicated technical catalogue PDE2628TCUK



PVL-B2

3 Porting options for an optimized flow



Push-In Fittings

- 6 mm OD Qn 490 NI/mn (Qmax. 780 NI/mn)
- 8 mm OD Qn 710 NI/mn (Qmax. 1100 NI/mn)



Threaded ports

- G1/8" Qn 640 NI/mn (Qmax. 900 NI/mn)

2 Electrical Pilot options

10 mm Pilot Solenoid Valve

Pins-UP option



Non locking Manual Override

24 Vdc – Low power (1W)

Economic electrical connection
by Clip Connector – IP40

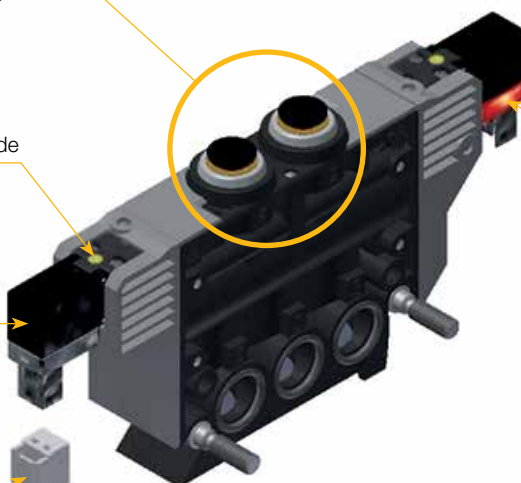

Integrated
LED Indicator



Pneumatic Symbol

15 mm DIN For C Pilot Solenoid Valve



Standard DIN Form C connectors – IP65
8 mm spacing



Pins-DOWN option

Wide range of DC and AC Voltage options

5 manual override options

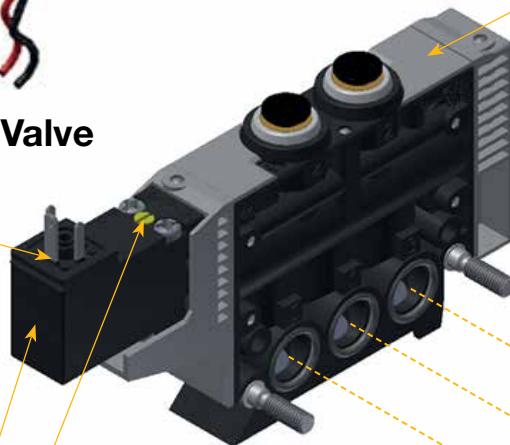

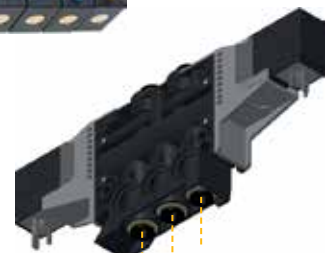

Common Supply and Exhaust Channels
for stackable design



Supply and Exhaust Bottom Ported
for Stand-alone design



Technical Characteristics

Description		PVL-B21 (Stand-alone) – PVL-B22 (Stackable)		
Port size	Head and Tail	Supply and Exhaust ports : 1/4"		
	Valve	6 mm push-in fitting	8 mm push-in fitting	Treaded G1/8"
Flow rate	Qn	490 NI/mn	710 NI/mn	640 NI/mn
	Qmax	780 NI/mn	1100 NI/mn	900 NI/mn
Fluid	Air or inert gas, filtered 40µ, dry or lubricated (according to ISO 8573-1 class 3.4.3.)			
Vibration resistance	2g at 2 to 150 Hz according to IEC68-2-6			
Chock resistance	15g 11ms according to IEC68-2-27			
 <p style="text-align: center;">Valve Characteristics equipped with 15 mm pilot solenoid valve</p>				
Operating pressure	Monostable	3 to 10 bar (5/3 functions : 3 to 8 bar)		
	Bistable	2 to 10 bar		
Temperature range	Operating	-15°C to +60°C		
	Stocking	-40°C to +70°C		
Response time (@ 6 bar / 20°C)	Monostable	Spring return : Pilot : 15 ms / Return : 25 ms Air Spring return : Pilot : 20 ms / Return : 25 ms		
	Bistable	15 ms		
Max. operating frequency	Monostable	5 Hz		
	Bistable	10 Hz		
Standard voltage	DC	12 Vdc / 24 Vdc / 48 Vdc		
	AC	24 Vac / 48 Vac / 115 Vac / 230 Vac		
Power consumption	DC	1,2 W		
	AC	Hold	1,6 VA	
		Inrush	3,5 VA	
Voltage tolerance	+10% / -15% of rated voltage (at 20°C)			
Visualisation	Without (optional in connector)			
Surge protection	Without (optional in connector)			
Connection	DIN Form C - 8 mm spacing			
Dust and water protection rating	IP65 (with connector)			
 <p style="text-align: center;">Valve Characteristics equipped with 10 mm pilot solenoid valve</p>				
Operating pressure	Monostable	3 to 8 bar		
	Bistable	2 to 8 bar		
Temperature range	Operating	-5°C to +50°C		
	Stocking	-40°C to +70°C		
Response time (@ 6 bar / 20°C)	Monostable	Spring return : Pilot : 15 ms / Return : 35 ms Air Spring return : Pilot : 15 ms / Return : 35 ms		
	Bistable	12 ms		
Max. operating frequency	Monostable	5 Hz		
	Bistable	10 Hz		
Standard voltage	DC	24 Vdc (other voltage on request)		
	AC	(on request)		
Power consumption	1 W (including LED)			
Voltage tolerance	+10% / -10% of rated voltage (at 20°C)			
Visualisation	Included on 10 mm pilot solenoid valve			
Surge protection	Included on 10 mm pilot solenoid valve			
Connection	Clip connector - Polarized			
Dust and water protection rating	IP40 (with Connector)			

Recommended air quality for valves

For best possible service life and trouble free operation, ISO 8573-1 quality class 3.4.3 should be used. This means 5µm filter (standard filter) dew point +30° C for indoor operation (a lower dew point should be selected for outdoor operation) and oil concentration 1.0 mg oil/m³, which is what a standard compressor with a standard filter gives.

ISO 8573-1 quality classes

Quality class	Pollution		Water	Oil
	Particle size (µm)	max. concentration (mg/m ³)	max. press. dew point (°C)	max. concentration (mg/m ³)
1	0,1	0,1	-70	0,01
2	1	1	-40	0,1
3	5	5	-20	1,0
4	15	8	+3	5,0
5	40	10	+7	25
6	-	-	+10	-

Typical cylinders speeds which can be achieved with PVL-B2 vs PVL-B valves and different tube sizes.

In the chart below you can find the suitable valves, tubes etc. for each cylinder size. If you have a tube length over 2 m, choose one tube size larger than in the chart.

Following data is valid:

- Supply pressure : min 7,0 bar
- Regulator pressure setting : 6,0 bar
- Pipe length between air treatment unit and valve : max 1 m
- Pipe length between valve and cylinder : max 2 m

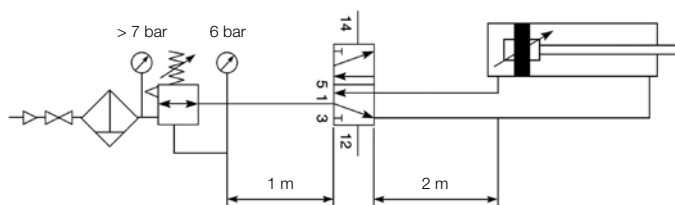

Cylinder bore (mm)		<20	20 to 32	40 - 50	63	80
Cylinder port size		M5	G1/8"	G1/4"	G3/8"	G3/8"
Tubing size (Int. / Ext.)		2,7 / 4	4 / 6	6 / 8	8 / 10	8 / 10
				4 / 6	6 / 8	9 / 12
Push-in fitting 6 mm OD	PVL-B					
	PVL-B2					
Push-in fitting 8 mm OD						
Threaded G1/8"	PVL-B					
	PVL-B2					

Cylinder speed > 1 m/s

Cylinder speed < 0,5 m/s

Oversized

Cylinder speed < 1 m/s

PVL-B22 - Stackable Series

Stacking high flow valves with 10 or 15mm DIN C Pilot Solenoid Valve. Light weight plastic bodies feature push-in or threaded connection. Stacking valves feature modular inlet and exhaust facility.

- High flow – Compact size with a 18 mm width body
- Push-in fitting diameter 6mm, 8mm or threaded G1/8"
- DIN rail or surface mounting
- Economic clip connector (IP40) or DIN Form C connection (IP65)
- Light weight construction



PVL-B22 - Valve module

Equipped with 10mm - 24 Vdc - 1W pilot solenoid valve – LED Indicator – Pins Down*

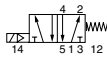
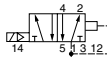
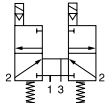
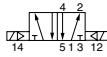
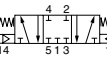
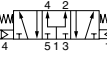
Symbol	Description	Pilot Man. Overr.	Connection	W (g)	Order code
	5/2 single acting spring return	Non-locking flush	Push-in 6mm	165	PVL-B2213062C1
			Push-in 8mm	165	PVL-B2213082C1
			G1/8"	165	PVL-B2213182C1
	5/2 single acting air spring return	Non-locking flush	Push-in 6mm	165	PVL-B2233062C1
			Push-in 8mm	165	PVL-B2233082C1
			G1/8"	165	PVL-B2233182C1
	Dual 3/2 N.C. spring return	Non-locking flush	Push-in 6mm	210	PVL-B2253062C1
			Push-in 8mm	210	PVL-B2253082C1
			G1/8"	210	PVL-B2253182C1
	5/2 Double acting	Non-locking flush	Push-in 6mm	200	PVL-B2223062C1
			Push-in 8mm	200	PVL-B2223082C1
			G1/8"	200	PVL-B2223182C1
	5/3 Closed center (APB)	Non-locking flush	Push-in 6mm	210	PVL-B2273062C1
			Push-in 8mm	210	PVL-B2273082C1
			G1/8"	210	PVL-B2273182C1
	5/3 Pressurised center	Non-locking flush	Push-in 6mm	210	PVL-B2293062C1
			Push-in 8mm	210	PVL-B2293082C1
			G1/8"	210	PVL-B2293182C1



* Other electrical connection orientations or low voltages DC on demand (can be subject to quantity)

10 mm Pilot solenoid valve electrical clip connector

Description	Connector type	Cable length	W (g)	Order code
 <p>Clip-on connector – IP40 Individual : Including 2 flying leads Multiple : Including 1 common (0 Vdc) and 1 flying lead per connector</p>	1 clip connector	1 meter	8	P8LW021C
	2 clip connectors	1 meter	12	P8LW021C02
	4 clip connectors	1 meter	20	P8LW021C04
	8 clip connectors	1 meter	36	P8LW021C08

PVL-B22 - Valve module

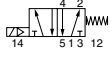
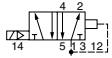
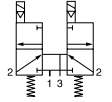
Equipped with 15mm DIN Form C (8mm spacing) - 24 Vdc - 1,2W pilot solenoid valve – Pins Up

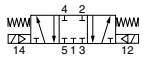
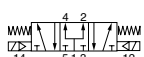



	Symbol	Description	Pilot Man. Overr.	Connection	W (g)	Order code
		5/2 single acting spring return	Locking flush	Push-in 6mm	165	PVL-B2216062C2
				Push-in 8mm	165	PVL-B2216082C2
				G1/8"	165	PVL-B2216182C2
		5/2 single acting air spring return	Locking flush	Push-in 6mm	165	PVL-B2236062C2
				Push-in 8mm	165	PVL-B2236082C2
				G1/8"	165	PVL-B2236182C2
		Dual 3/2 N.C. spring return	Locking flush	Push-in 6mm	210	PVL-B2256062C2
				Push-in 8mm	210	PVL-B2256082C2
				G1/8"	210	PVL-B2256182C2
		5/2 Double acting	Non-locking flush	Push-in 6mm	200	PVL-B2226062C1
				Push-in 8mm	200	PVL-B2226082C1
				G1/8"	200	PVL-B2226182C1
		5/3 Closed center (APB)	Locking flush	Push-in 6mm	210	PVL-B2276062C2
				Push-in 8mm	210	PVL-B2276082C2
				G1/8"	210	PVL-B2276182C2
		5/3 Pressurised center	Locking flush	Push-in 6mm	210	PVL-B2296062C2
				Push-in 8mm	210	PVL-B2296082C2
				G1/8"	210	PVL-B2296182C2

For other 15mm pilot valve options (voltage, manual override or pins orientation), valve body and 15mm pilot valve must be ordered separately (see below)

PVL-B22 - Valve module

(Without Pilot solenoid valve – including 2 mounting screws for Pilot solenoid valve)

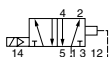
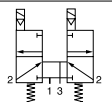
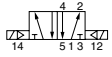
For use with 15mm DIN Form C (8mm spacing) Pins UP or Pins DOWN pilot solenoid valve

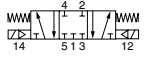
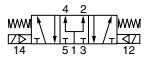
	Symbol	Description	Connection	W (g)	Order code
		5/2 single acting spring return	Push-in 6mm	125	PVL-B221606
			Push-in 8mm	125	PVL-B221608
			G1/8"	125	PVL-B221618
		5/2 single acting air spring return	Push-in 6mm	125	PVL-B223606
			Push-in 8mm	125	PVL-B223608
			G1/8"	125	PVL-B223618
		Dual 3/2 N.C. spring return	Push-in 6mm	130	PVL-B225606
			Push-in 8mm	130	PVL-B225608
			G1/8"	130	PVL-B225618
		5/2 Double acting	Push-in 6mm	120	PVL-B222606
			Push-in 8mm	120	PVL-B222608
			G1/8"	120	PVL-B222618
		5/3 Closed center (APB)	Push-in 6mm	130	PVL-B227606
			Push-in 8mm	130	PVL-B227608
			G1/8"	130	PVL-B227618
		5/3 Pressurised center	Push-in 6mm	130	PVL-B229606
			Push-in 8mm	130	PVL-B229608
			G1/8"	130	PVL-B229618

15mm DIN Form C (8mm spacing) pilot solenoid valve – Pin's UP or Pin's DOWN – must be ordered separately (Refer to 15 mm pilot valve section)

Head and Tail sets – Intermediate supply modules

	Description	Mounting	Air supply	Port size	W (g)	Order code
	Head and tail set	On DIN rail	Left end	G1/4"	175	PVL-B1719
			Both left and right ends	G1/4"	195	PVL-B1729
	Intermediate module	On surface	Left end	G1/8"	175	PVL-B1818
			Both left and right ends	G1/8"	195	PVL-B1828
	Intermediate module	On DIN rail	Up side	G1/8"	150	PVU-LBB118

Pneumatic accessories

	Description	Size	Orientation	Material	Tube OD	W (g)	Order code
	Push-in fitting for Pressure and Exhaust ports	G1/4"	Straight	Metal	8 mm	16	3101 08 13
					10 mm	18	3101 10 13
					12 mm	27	3101 12 13
			Elbow	Metal/Plastic	8 mm	21	3199 08 13
					10 mm	28	3199 10 13
					12 mm	44	3199 12 13
	Silencer	G1/4"	Straight	Plastic		10	P6M-PAB2
				Sintered metal		20	P6M-BAA2
	Push-in fitting for PVL-B2 Valve	G1/8"	Straight	Metal	4 mm	6	3101 04 10
					6 mm	7	3101 06 10
					8 mm	11	3101 08 10
			Elbow prolonged	Plastic	4 mm	8	3169 04 10
					6 mm	11	3169 06 10
					8 mm	18	3169 08 10
			Elbow short	Plastic	4 mm	6	3199 04 10
					6 mm	6	3199 06 10
					8 mm	9	3199 08 10
		6 mm	Elbow prolonged	Plastic	4 mm	2	3184 04 06
					6 mm	4	3184 06 00
					8 mm	10	3184 08 00
			Elbow short	Plastic	4 mm	3	3182 04 06
					6 mm	1	3182 06 00
					8 mm	10	3182 08 00
		8 mm	Elbow prolonged	Plastic	6 mm	7	3184 06 08
					8 mm	10	3184 08 00
					6 mm	7	3182 06 08
			Elbow short	Plastic	6 mm	7	3182 06 08
					8 mm	10	3182 08 00

Spare mounting and assembly kits

	Description	W (g)	Order code
	Sealing kit for supply/exhaust common channels Included : <ul style="list-style-type: none"> • 3 common blanking plugs • 2 drilled and threaded rods • 2 screws for extended tie rod 	35	PVL-B1901
	Pack of 10 common blanking	35	PVL-B1902
	Pack of 10 stacking rods	35	PPR-V21
	Pack of 20 rail clip assembly	70	PPR-L09
	Pack of 30 O-ring seals for supply/exhaust common channels	15	PPR-V23

Mounting on 35 mm DIN Rail

Valve stacks mount quickly and easily to 35 mm DIN rail with the use of a pneumatic head / tail set. The dual head / tail set provides input and exhaust ports at both ends and is recommended if more than 5 valves are to be operated simultaneously.

Surface mounting

For single or dual air supply

This mounting does not use DIN rail and can be directly fixed on the panel. Particularly compact and threaded G1/8", it is recommended for combinations of only a few power valves (maximum 5 valves) since the supply and exhaust common ports 1-3-5 are not G1/4" oversized.

Removal or Replacement

Modules are removed in reverse of the order shown at right. Before removing a module for service or replacement, loosen the pneumatic tail piece.

Mounting Procedure

- 1 - Clip on and tighten the pneumatic head piece.



- 2 - Assemble the two parallel mounting rods using cross rod provided with modules.



- 3 - Clip on the pneumatic tail piece. Start screws into mounting rod but leave loose for modules insertion.



- 4 - To mount valves, position upper slot then push-lock lower slot. Mount modules (valves, modules, transition pieces, etc...) and press together.

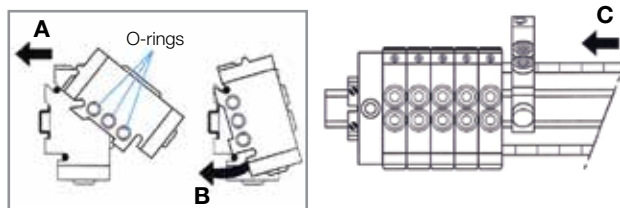

- 5 - Tighten the assembly.

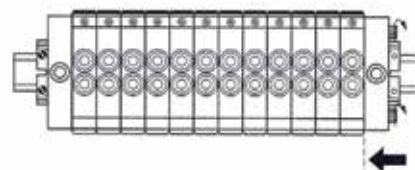

PVL-B21 - Stand-alone Series

Stand-alone high flow valves with 10 or 15mm DIN C Pilot Solenoid Valve. Light weight plastic bodies feature push-in or threaded connection.

- High flow – Compact size with a 18 mm width body
- Push-in fitting diameter 6mm, 8mm or threaded G1/8"
- Economic clip connector (IP40) or DIN Form C connection (IP65)
- Light weight construction
- Compatible with stackable version



PVL-B21 - Valve module

Equipped with 10mm - 24 Vdc - 1W pilot solenoid valve – LED Indicator – Pins Down*

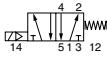
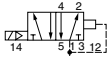
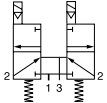
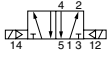
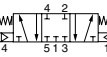
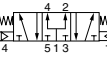
Symbol	Description	Pilot Man. Overr.	Connection	W (g)	Order code
	5/2 single acting spring return	Non-locking flush	Push-in 6mm	165	PVL-B2113062C1
			Push-in 8mm	165	PVL-B2113082C1
			G1/8"	165	PVL-B2113182C1
	5/2 single acting air spring return	Non-locking flush	Push-in 6mm	165	PVL-B2133062C1
			Push-in 8mm	165	PVL-B2133082C1
			G1/8"	165	PVL-B2133182C1
	Dual 3/2 N.C. spring return	Non-locking flush	Push-in 6mm	210	PVL-B2153062C1
			Push-in 8mm	210	PVL-B2153082C1
			G1/8"	210	PVL-B2153182C1
	5/2 Double acting	Non-locking flush	Push-in 6mm	200	PVL-B2123062C1
			Push-in 8mm	200	PVL-B2123082C1
			G1/8"	200	PVL-B2123182C1
	5/3 Closed center (APB)	Non-locking flush	Push-in 6mm	210	PVL-B2173062C1
			Push-in 8mm	210	PVL-B2173082C1
			G1/8"	210	PVL-B2173182C1
	5/3 Pressurised center	Non-locking flush	Push-in 6mm	210	PVL-B2193062C1
			Push-in 8mm	210	PVL-B2193082C1
			G1/8"	210	PVL-B2193182C1



* Other electrical connection orientations or low voltages DC on demand (can be subject to quantity)

10 mm Pilot solenoid valve electrical clip connector

Description	Connector type	Cable length	W (g)	Order code	
	Clip-on connector – IP40	1 clip connector	1 meter	8	P8LW021C
	Individual : Including 2 flying leads	2 clip connectors	1 meter	12	P8LW021C02
	Multiple : Including 1 common (0 Vdc) and 1 flying lead per connector	4 clip connectors	1 meter	20	P8LW021C04
		8 clip connectors	1 meter	36	P8LW021C08

PVL-B21 - Valve module

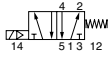
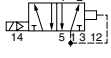
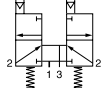
Equipped with 15mm DIN Form C (8mm spacing) - 24 Vdc - 1,2W pilot solenoid valve – Pins Up

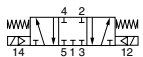
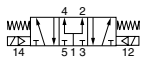



	Symbol	Description	Pilot Man. Overr.	Connection	W (g)	Order code	
		5/2 single acting spring return	Locking flush	Push-in 6mm	165	PVL-B2116062C2	
				Push-in 8mm	165	PVL-B2116082C2	
				G1/8"	165	PVL-B2116182C2	
			5/2 single acting air spring return	Locking flush	Push-in 6mm	165	PVL-B2136062C2
					Push-in 8mm	165	PVL-B2136082C2
					G1/8"	165	PVL-B2136182C2
			Dual 3/2 N.C. spring return	Locking flush	Push-in 6mm	210	PVL-B2156062C2
					Push-in 8mm	210	PVL-B2156082C2
					G1/8"	210	PVL-B2156182C2
		5/2 Double acting	Non-locking flush	Push-in 6mm	200	PVL-B2126062C1	
				Push-in 8mm	200	PVL-B2126082C1	
				G1/8"	200	PVL-B2126182C1	
			5/3 Closed center (APB)	Locking flush	Push-in 6mm	210	PVL-B2176062C2
					Push-in 8mm	210	PVL-B2176082C2
					G1/8"	210	PVL-B2176182C2
			5/3 Pressurised center	Locking flush	Push-in 6mm	210	PVL-B2196062C2
					Push-in 8mm	210	PVL-B2196082C2
					G1/8"	210	PVL-B2196182C2

For other 15mm pilot valve options (voltage, manual override or pins orientation), valve body and 15mm pilot valve must be ordered separately (see below)

PVL-B21 - Valve module

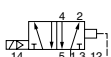
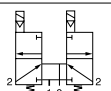

(Without Pilot solenoid valve – including 2 mounting screws for Pilot solenoid valve)

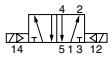
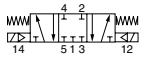
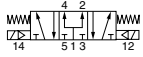
For use with 15mm DIN Form C (8mm spacing) Pins UP or Pins DOWN pilot solenoid valve

	Symbol	Description	Connection	W (g)	Order code	
		5/2 single acting spring return	Push-in 6mm	125	PVL-B211606	
			Push-in 8mm	125	PVL-B211608	
			G1/8"	125	PVL-B211618	
			5/2 single acting air spring return	Push-in 6mm	125	PVL-B213606
				Push-in 8mm	125	PVL-B213608
				G1/8"	125	PVL-B213618
			Dual 3/2 N.C. spring return	Push-in 6mm	130	PVL-B215606
				Push-in 8mm	130	PVL-B215608
				G1/8"	130	PVL-B215618
		5/2 Double acting	Push-in 6mm	120	PVL-B212606	
			Push-in 8mm	120	PVL-B212608	
			G1/8"	120	PVL-B212618	
			5/3 Closed center (APB)	Push-in 6mm	130	PVL-B217606
				Push-in 8mm	130	PVL-B217608
				G1/8"	130	PVL-B217618
			5/3 Pressurised center	Push-in 6mm	130	PVL-B219606
				Push-in 8mm	130	PVL-B219608
				G1/8"	130	PVL-B219618

15mm DIN Form C (8mm spacing) pilot solenoid valve – Pin's UP or Pin's DOWN – must be ordered separately (Refer to 15 mm pilot valve section)

Pneumatic accessories

	Description	Size	Orientation	Material	Tube OD	W (g)	Order code			
 <p>3101 ...</p>	Push-in fitting for PVL-B2 Valve	G1/8"	Straight	Metal	4 mm	6	3101 04 10			
					6 mm	7	3101 06 10			
					8 mm	11	3101 08 10			
 <p>3169 ... 3199 ...</p>			Elbow prolonged	Plastic	4 mm	8	3169 04 10			
					6 mm	11	3169 06 10			
					8 mm	18	3169 08 10			
					6 mm	Elbow short	Plastic	4 mm	6	3199 04 10
								6 mm	6	3199 06 10
								8 mm	9	3199 08 10
 <p>3184 ... 3182 ...</p>		6 mm	Elbow prolonged	Plastic	4 mm	2	3184 04 06			
					6 mm	4	3184 06 00			
			Elbow short	Plastic	4 mm	3	3182 04 06			
					6 mm	1	3182 06 00			
			8 mm	Elbow prolonged	Plastic	6 mm	7	3184 06 08		
						8 mm	10	3184 08 00		
Elbow short	Plastic	6 mm	7	3182 06 08						
		8 mm	10	3182 08 00						

PVL-B2 – 10 mm pilot solenoid valve options

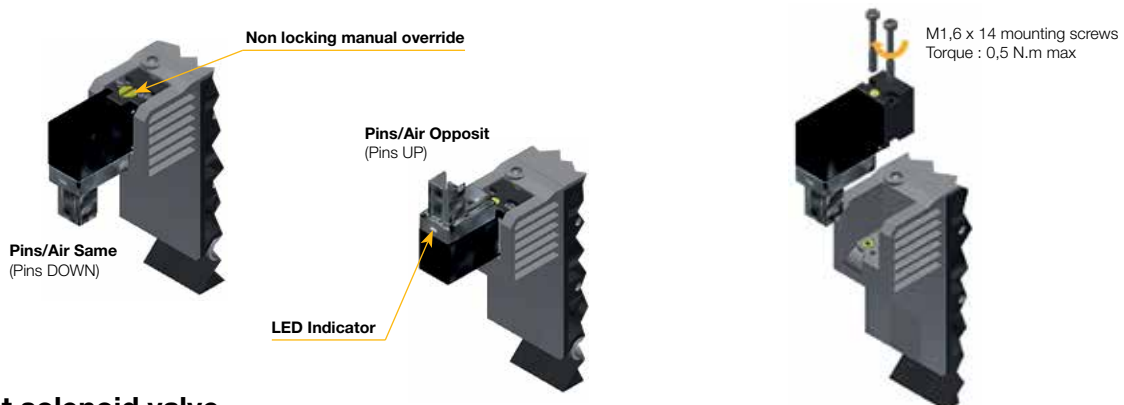

10 mm pilot solenoid valve

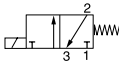
	Voltage	Electrical connection orientation	Manual Override	W (g)	Order code
 	24 Vdc	PINS /AIR same (PINS down)	Non-locking flush	20	P2D-KS32C1
		PINS/AIR opposit (PINS UP)	Non-locking flush	20	P2D-KV32C1

Other electrical connection orientations or low voltages DC on demand (can be subject to quantity)

10 mm Pilot solenoid valve electrical clip connector

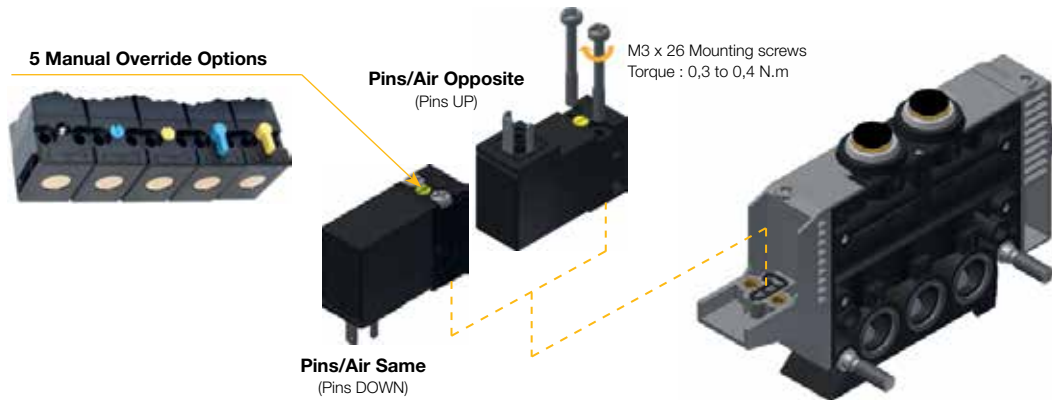

Description	Connector type	Cable length	W (g)	Order code
 <p>Clip-on connector – IP40 Individual : Including 2 flying leads Multiple : Including 1 common (0 Vdc) and 1 flying lead per connector</p>	1 clip connector	1 meter	8	P8LW021C
	2 clip connectors	1 meter	12	P8LW021C02
	4 clip connectors	1 meter	20	P8LW021C04
	8 clip connectors	1 meter	36	P8LW021C08

PVL-B2 – 15 mm pilot solenoid valve options

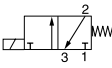

15mm DIN Form C (8mm spacing) pilot solenoid valve

For use with 15mm pilot solenoid valve PVL-B2 body

	Manual Overrides		Flush (Not Extended)			Extended	
	Voltage	W (g)	Without Manual Override	Blue Override, non locking	Yellow Override, Locking	Blue Override, non locking	Yellow Override, Locking
 Pins/Air Opposite (Pins UP)	12 Vdc	38	P2E-KV32B0	P2E-KV32B1	P2E-KV32B2	P2E-KV32B3	P2E-KV32B4
	24 Vdc	38	P2E-KV32C0	P2E-KV32C1	P2E-KV32C2	P2E-KV32C3	P2E-KV32C4
	48 Vdc	38	P2E-KV32D0	P2E-KV32D1	P2E-KV32D2	P2E-KV32D3	P2E-KV32D4
	24 Vac 50Hz	38	P2E-KV31C0	P2E-KV31C1	P2E-KV31C2	P2E-KV31C3	P2E-KV31C4
	48 Vac 50/60Hz	38	P2E-KV34D0	P2E-KV34D1	P2E-KV34D2	P2E-KV34D3	P2E-KV34D4
 Pins/Air Same (Pins DOWN)	115 Vac 50Hz	38	P2E-KV31F0	P2E-KV31F1	P2E-KV31F2	P2E-KV31F3	P2E-KV31F4
	120 Vac 60 Hz	38					
	230 Vac 50Hz	38	P2E-KV31J0	P2E-KV31J1	P2E-KV31J2	P2E-KV31J3	P2E-KV31J4
	240 Vac 60 Hz	38					
	12 Vdc	38	P2E-KS32B0	P2E-KS32B1	P2E-KS32B2	P2E-KS32B3	P2E-KS32B4
	24 Vdc	38	P2E-KS32C0	P2E-KS32C1	P2E-KS32C2	P2E-KS32C3	P2E-KS32C4
	48 Vdc	38	P2E-KS32D0	P2E-KS32D1	P2E-KS32D2	P2E-KS32D3	P2E-KS32D4
	24 Vac 50Hz	38	P2E-KS31C0	P2E-KS31C1	P2E-KS31C2	P2E-KS31C3	P2E-KS31C4
	48 Vac 50/60Hz	38	P2E-KS34D0	P2E-KS34D1	P2E-KS34D2	P2E-KS34D3	P2E-KS34D4
	115 Vac 50Hz	38	P2E-KS31F0	P2E-KS31F1	P2E-KS31F2	P2E-KS31F3	P2E-KS31F4
120 Vac 60 Hz	38						
230 Vac 50Hz	38	P2E-KS31J0	P2E-KS31J1	P2E-KS31J2	P2E-KS31J3	P2E-KS31J4	
240 Vac 60 Hz	38						

Mounting screws included with the valve body

Pilot solenoid valve mounting screw

Description	Size	Material	W (g)	Order code
 Kit of 10 mounting screws	M23 x 26	Steel	20	P2E-KP026PM3

Cable plugs 15 mm - IP65

(8 mm pin spacing)

Description	Electrical protection	Cable length	W (g)	Order code
 Standard screw	No protection	No cable	11	P8C-D
		2 meter	97	P8L-C2
		5 meter	228	P8L-C5
	LED + Protection 24 VDC	No cable	11	P8C-D26C
	LED + Protection 24 VDC/AC	2 meter	97	P8L-C226C
		5 meter	229	P8L-C526C

Suppressor and LED indicators

For 8 mm solenoid pin spacing - For mounting between the solenoid valve and the cable plug

Symbol	Description	Electrical Voltage	W (g)	Order code
	LED indicator	24 VAC/DC	3	P8V-CR26C
		115 VAC 50 Hz - 120 VAC 60 Hz	3	P8V-CR24F
		230 VAC 50 Hz - 240 VAC 60 Hz	3	P8V-CR24J

PVL-B21 (Stand-alone) & PVL-B22 (Stackable) – with 15 mm pilot solenoid valve – Pins UP

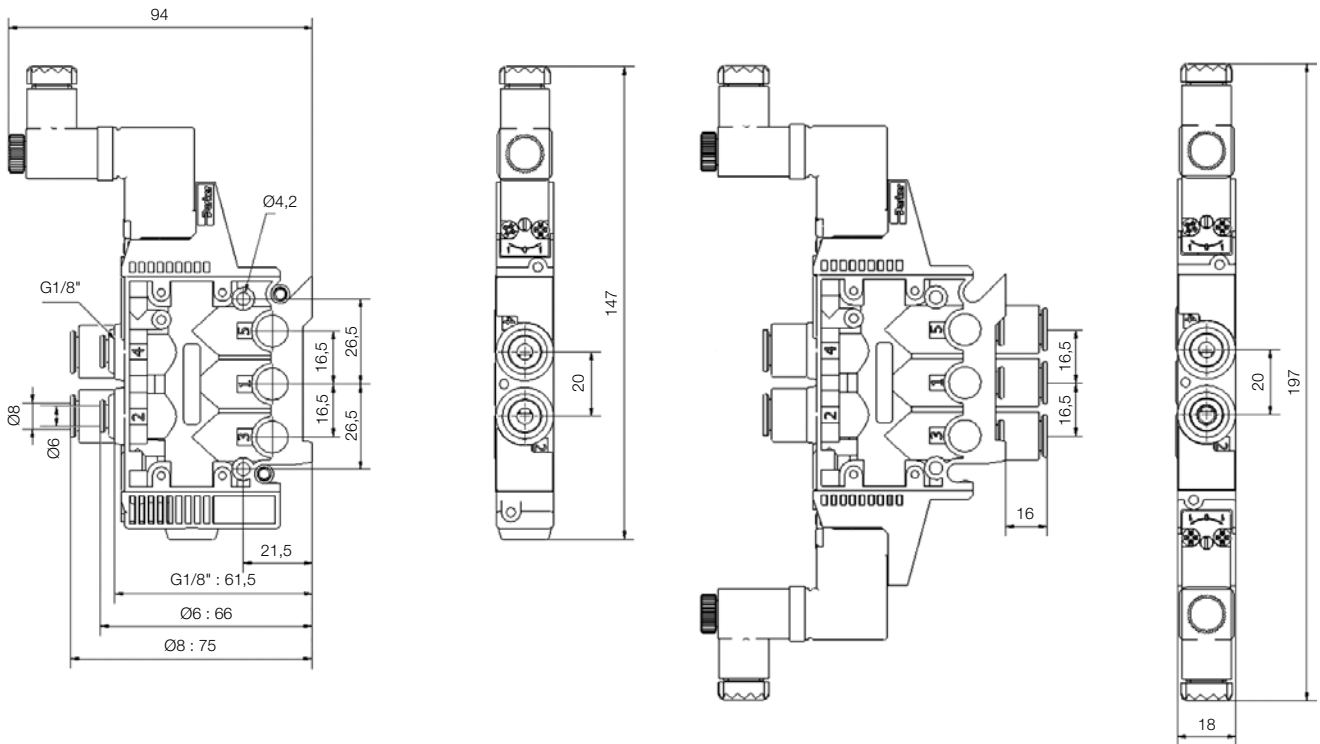

PVL-B21 (Stand-alone) & PVL-B22 (Stackable) – with 15 mm pilot solenoid valve – Pins DOWN

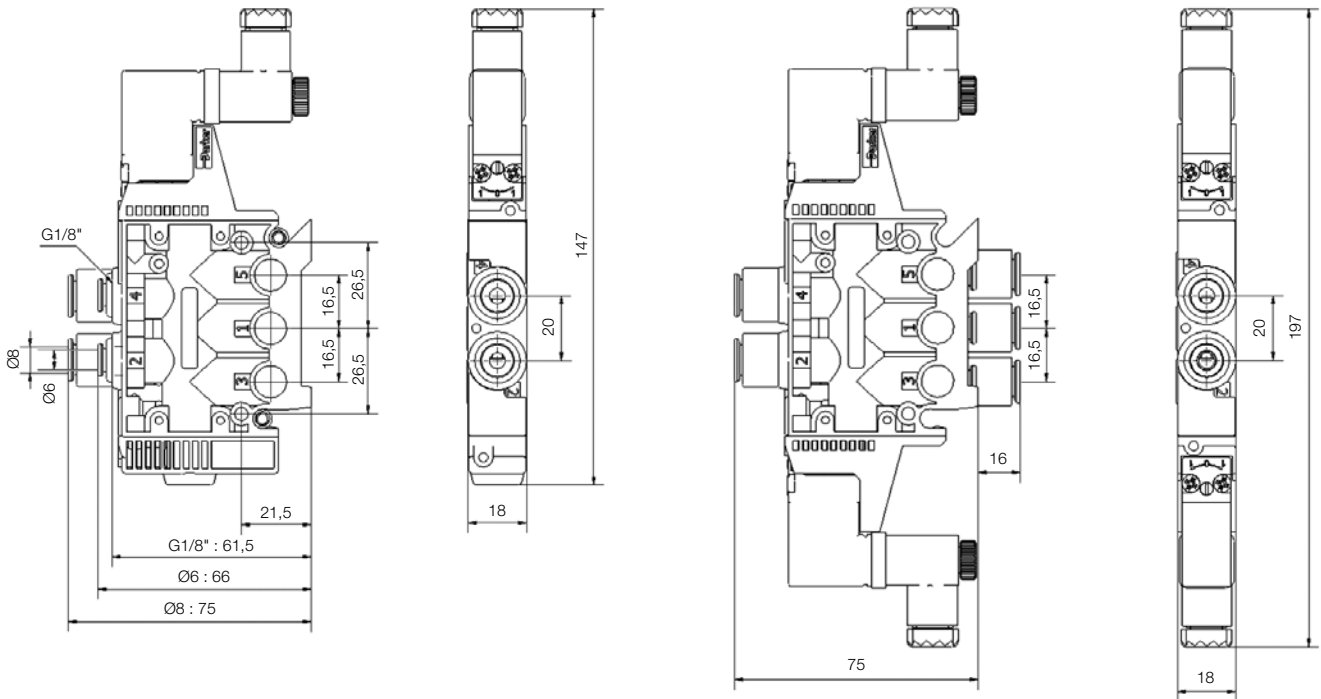

PVL-B21 (Stand-alone) & PVL-B22 (Stackable) – with 10 mm pilot solenoid valve – Pins DOWN

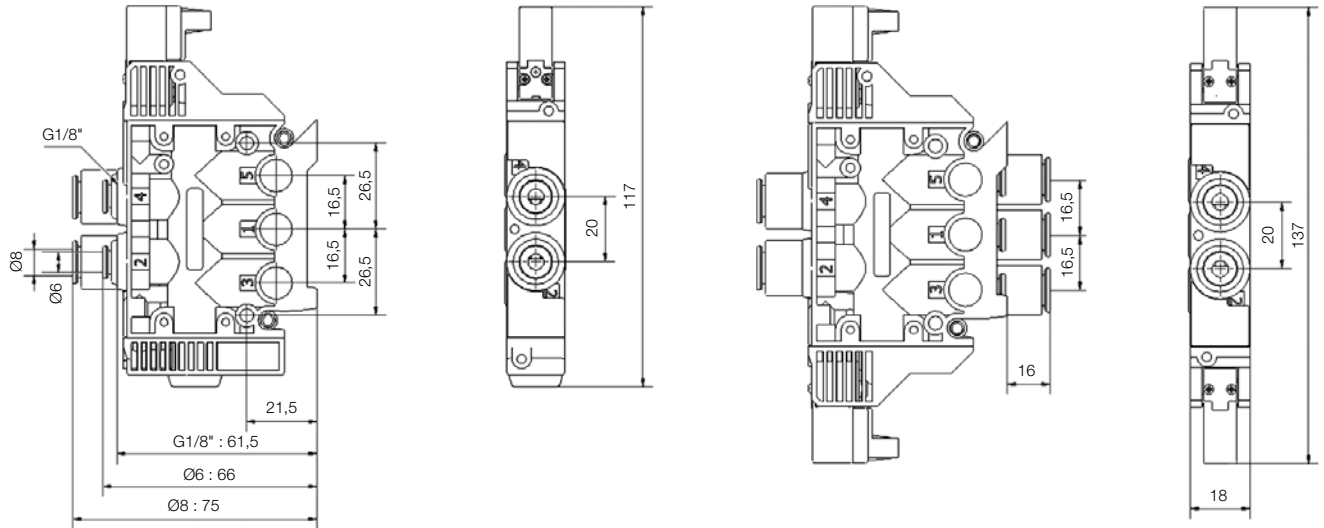

PVL-B21 (Stand-alone) & PVL-B22 (Stackable) – with 10 mm pilot solenoid valve – Pins UP

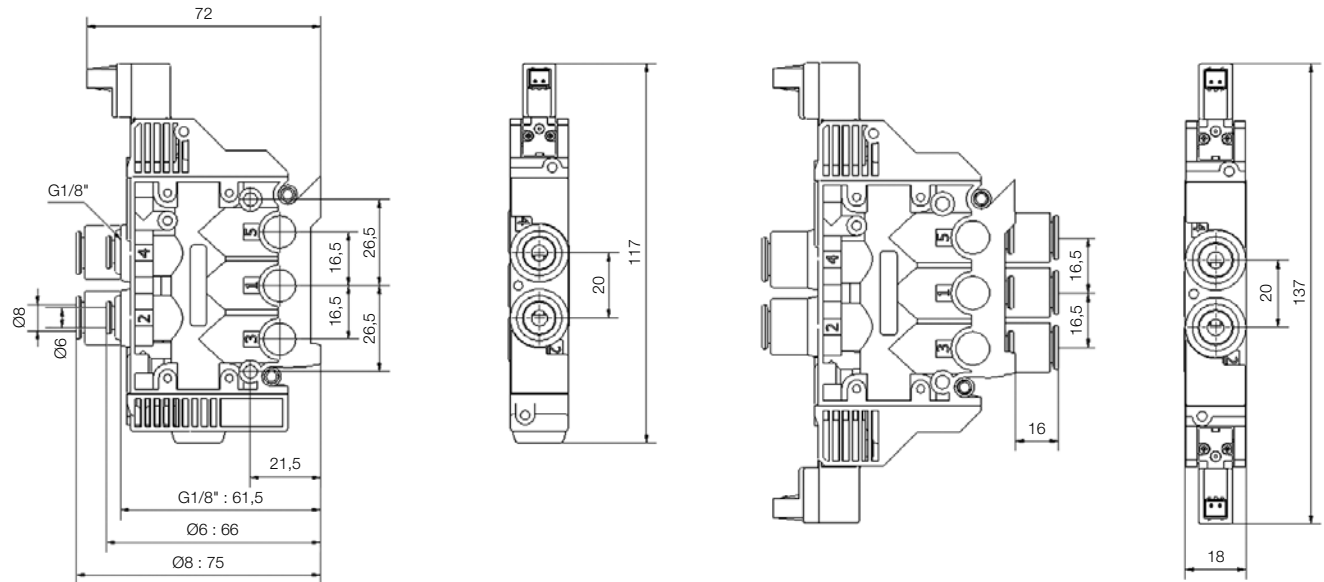

PVL-B22 (Stackable) – Head and Tail sets – DIN rail mounting

Single air supply – PVL-B1719

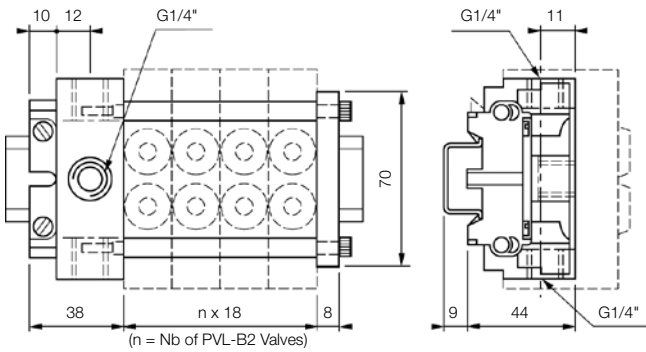

Dual air supply – PVL-B1729

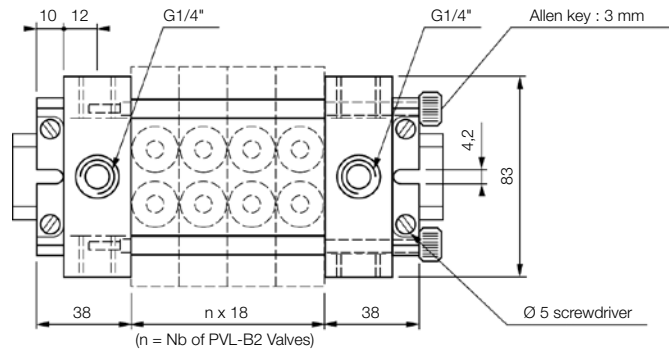

PVL-B22 (Stackable) – Head and Tail sets – Surface mounting

Single air supply – PVL-B1818

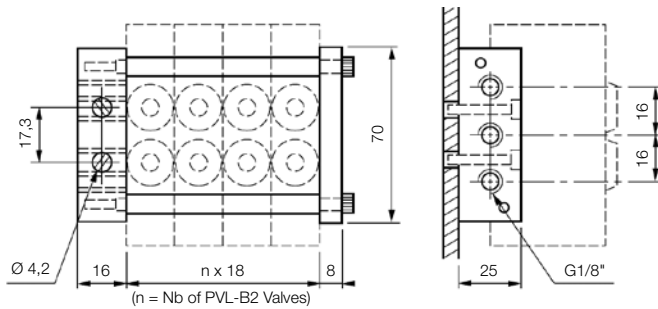

Dual air supply – PVL-B1828

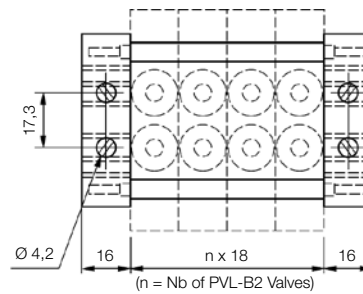

PVL-B22 (Stackable) – Intermediate supply module – PVU-LBB118

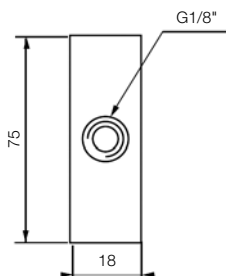

Parker Worldwide

Europe, Middle East, Africa

AE – United Arab Emirates, Dubai
Tel: +971 4 8127100
parker.me@parker.com

AT – Austria, Wiener Neustadt
Tel: +43 (0)2622 23501-0
parker.austria@parker.com

AT – Eastern Europe, Wiener Neustadt
Tel: +43 (0)2622 23501 900
parker.easteurope@parker.com

AZ – Azerbaijan, Baku
Tel: +994 50 2233 458
parker.azerbaijan@parker.com

BE/LU – Belgium, Nivelles
Tel: +32 (0)67 280 900
parker.belgium@parker.com

BG – Bulgaria, Sofia
Tel: +359 2 980 1344
parker.bulgaria@parker.com

BY – Belarus, Minsk
Tel: +48 (0)22 573 24 00
parker.poland@parker.com

CH – Switzerland, Etoy
Tel: +41 (0)21 821 87 00
parker.switzerland@parker.com

CZ – Czech Republic, Klecany
Tel: +420 284 083 111
parker.czechrepublic@parker.com

DE – Germany, Kaarst
Tel: +49 (0)2131 4016 0
parker.germany@parker.com

DK – Denmark, Ballerup
Tel: +45 43 56 04 00
parker.denmark@parker.com

ES – Spain, Madrid
Tel: +34 902 330 001
parker.spain@parker.com

FI – Finland, Vantaa
Tel: +358 (0)20 753 2500
parker.finland@parker.com

FR – France, Contamine s/Arve
Tel: +33 (0)4 50 25 80 25
parker.france@parker.com

GR – Greece, Athens
Tel: +30 210 933 6450
parker.greece@parker.com

HU – Hungary, Budaörs
Tel: +36 23 885 470
parker.hungary@parker.com

IE – Ireland, Dublin
Tel: +353 (0)1 466 6370
parker.ireland@parker.com

IL – Israel
Tel: +39 02 45 19 21
parker.israel@parker.com

IT – Italy, Corsico (MI)
Tel: +39 02 45 19 21
parker.italy@parker.com

KZ – Kazakhstan, Almaty
Tel: +7 7273 561 000
parker.easteurope@parker.com

NL – The Netherlands, Oldenzaal
Tel: +31 (0)541 585 000
parker.nl@parker.com

NO – Norway, Asker
Tel: +47 66 75 34 00
parker.norway@parker.com

PL – Poland, Warsaw
Tel: +48 (0)22 573 24 00
parker.poland@parker.com

PT – Portugal
Tel: +351 22 999 7360
parker.portugal@parker.com

RO – Romania, Bucharest
Tel: +40 21 252 1382
parker.romania@parker.com

RU – Russia, Moscow
Tel: +7 495 645-2156
parker.russia@parker.com

SE – Sweden, Spånga
Tel: +46 (0)8 59 79 50 00
parker.sweden@parker.com

SL – Slovenia, Novo Mesto
Tel: +386 7 337 6650
parker.slovenia@parker.com

TR – Turkey, Istanbul
Tel: +90 216 4997081
parker.turkey@parker.com

UA – Ukraine, Kiev
Tel: +48 (0)22 573 24 00
parker.poland@parker.com

UK – United Kingdom, Warwick
Tel: +44 (0)1926 317 878
parker.uk@parker.com

ZA – South Africa, Kempton Park
Tel: +27 (0)11 961 0700
parker.southafrica@parker.com

North America

CA – Canada, Milton, Ontario
Tel: +1 905 693 3000

US – USA, Cleveland
Tel: +1 216 896 3000

Asia Pacific

AU – Australia, Castle Hill
Tel: +61 (0)2-9634 7777

CN – China, Shanghai
Tel: +86 21 2899 5000

HK – Hong Kong
Tel: +852 2428 8008

IN – India, Mumbai
Tel: +91 22 6513 7081-85

JP – Japan, Tokyo
Tel: +81 (0)3 6408 3901

KR – South Korea, Seoul
Tel: +82 2 559 0400

MY – Malaysia, Shah Alam
Tel: +60 3 7849 0800

NZ – New Zealand, Mt Wellington
Tel: +64 9 574 1744

SG – Singapore
Tel: +65 6887 6300

TH – Thailand, Bangkok
Tel: +662 186 7000

TW – Taiwan, Taipei
Tel: +886 2 2298 8987

South America

AR – Argentina, Buenos Aires
Tel: +54 3327 44 4129

BR – Brazil, Sao Jose dos Campos
Tel: +55 800 727 5374

CL – Chile, Santiago
Tel: +56 2 623 1216

MX – Mexico, Toluca
Tel: +52 72 2275 4200

European Product Information Centre

Free phone: 00 800 27 27 5374

(from AT, BE, CH, CZ, DE, DK, EE, ES, FI, FR, IE, IL, IS, IT, LU, MT, NL, NO, PL, PT, RU, SE, SK, UK, ZA)



Parker Hannifin Ltd.

Tachbrook Park Drive
Tachbrook Park, Warwick CV34 6TU
United Kingdom
Tel.: +44 (0) 1926 317 878
Fax: +44 (0) 1926 317 855
parker.uk@parker.com
www.parker.com

DYSTRYBUTOR PARKER PREMIUM

ARA[®]
PNEUMATIK

| arapneumatik.pl

PARKER STORE WROCŁAW
pneumatyka@arapneumatik.pl
TEL. 71 364 72 80

PARKER STORE KATOWICE
katowice@arapneumatik.pl
TEL. 32 779 76 40

