

# Seria SPG

Ssawki dedykowane do pralin i ciastek  $\varnothing 12 \div 32$  mm



Ssawki dedykowane do pralin oraz innych produktów spożywczych (np. ciastek) to seria charakteryzująca się bardzo szerokim spektrum kształtów. Pozwala to na dobór ssawki odpowiednio dopasowanej do chwytanego wyrobu. Ssawki wykonane są z silikonu, który posiada dopuszczenie do kontaktu z żywnością.

Dedykowane dla branży

Dane techniczne



SPOŻYWCZA

Zastosowanie



Materiały

**SI** silikon

Kod zamówieniowy

**SPG 18-SI**

Ssawka serii SPG o śr. 18 mm, z silikonu

↑ seria    ↑ średnica    ↑ materiał

	$\varnothing A$ [mm]	$\varnothing$ otw. moc. [mm]	H [mm]	S [mm]	Masa (g)
SPG 12-SI	12	6	28	6	1,2
SPG 15-SI	15	4	32	6	1,8
SPG 16-SI	16	8	26	5	3,5
SPG 16/10-SI	16	10	20	6	1,6
SPG 17-SI	17,5	8	26	5	3,5
SPG 17/4-SI	17,5	3,8	11	1	1
SPG 18-SI	18	6	33	-	1,3
SPG 20-SI	20	4,5	25	-	1
SPG 22-SI	22	9	45	6	5,2
SPG2 22-SI	22	9	25	8	2
SPG 23-SI	23	7	42	1,5	5
SPG 25-SI	25	4,5	28	-	1,6
SPG 25/ZM8-SI	25	-	24	5	5
SPG 25/5-SI	25	5	25	1	2,7
SPG 32-SI	32	8	38	-	7
SPG2 32-SI	32	8	38	-	6

Wymiary

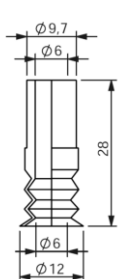

SPG 12

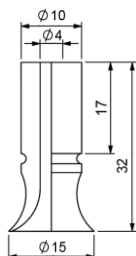

SPG 15

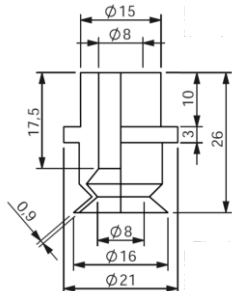

SPG 16

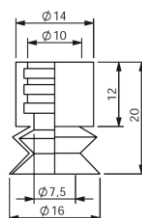

SPG 16/10

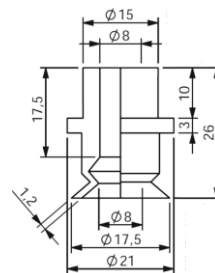

SPG 17

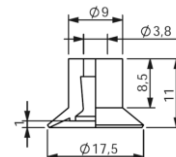

SPG 17/4

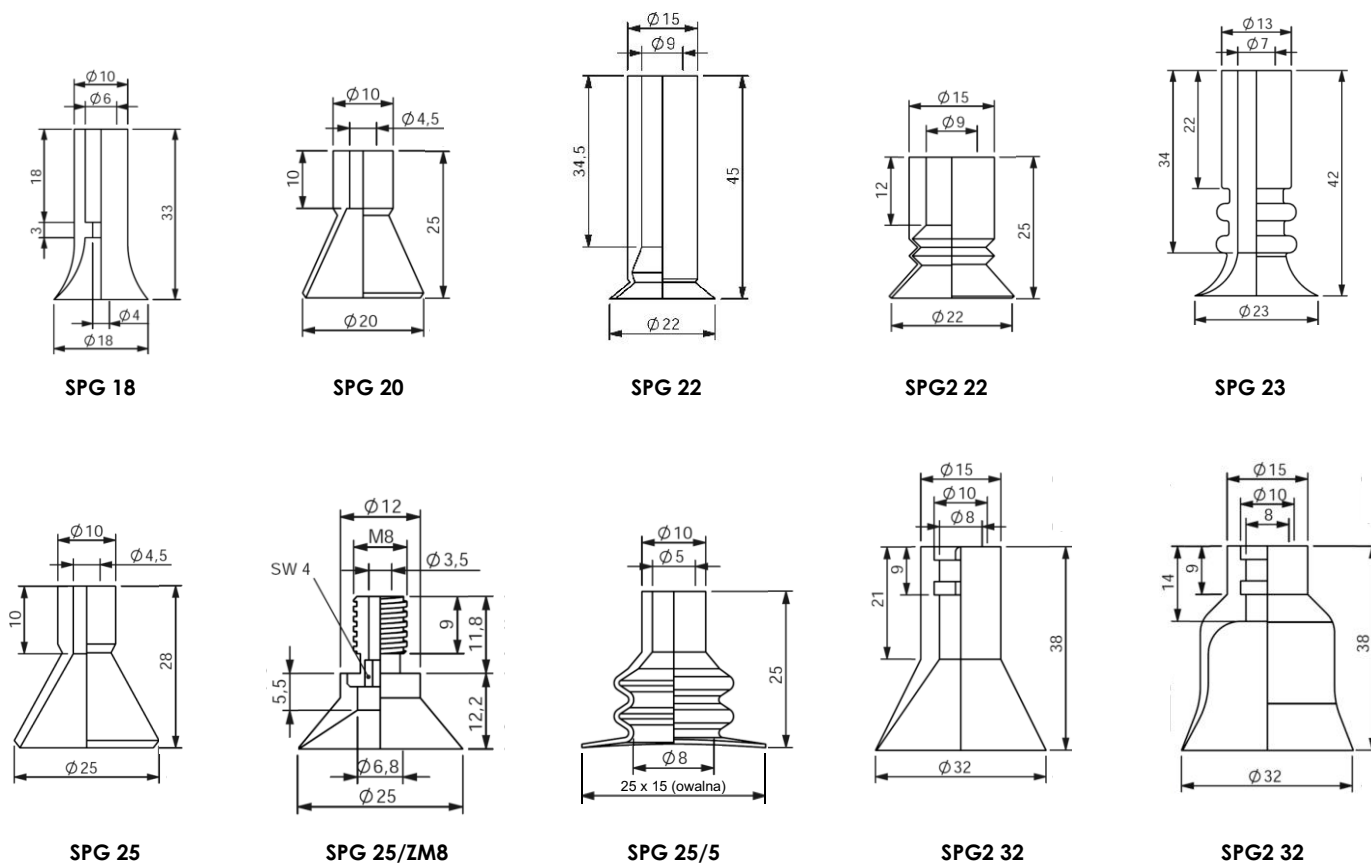

## Łączniki do ssawek

	M5 zewn.	M6 zewn.	1/8" zewn.	1/8" wewn.	1/4" zewn.	1/4" wewn.
<b>SPG 12</b>			N104-ZG18	N104-WG18		
<b>SPG 15</b>	N090-ZM5	N090-ZM6	N043-ZG18	N043-WG18		
<b>SPG 16</b>			N035-ZG18		N035-ZG14	N035-WG14
<b>SPG 16/10</b>	N103-ZM5				N103-ZG14	
<b>SPG 17</b>	N090-ZM5	N090-ZM6	N043-ZG18	N043-WG18		
<b>SPG 17/4</b>			N035-ZG18		N035-ZG14	N035-WG14
<b>SPG 18</b>			N104-ZG18	N104-WG18		
<b>SPG 20</b>	N090-ZM5	N090-ZM6	N043-ZG18	N043-WG18		
<b>SPG 22</b>			N100-ZG18		N100-ZG14	
<b>SPG2 22-SI</b>			N100-ZG18		N100-ZG14	
<b>SPG 23</b>			N035-ZG18		N035-ZG14	N035-WG14
<b>SPG 25</b>	N044-ZM5		N067-ZG18	N060-WG18		
<b>SPG 25/ZM8</b>	Zawulkanizowany łącznik M8, gwint zewnętrzny					
<b>SPG 25/5</b>	N044-ZM5		N067-ZG18	N060-WG18		
<b>SPG 32</b>			N100-ZG18		N100-ZG14	
<b>SPG2 32-SI</b>			N100-ZG18		N100-ZG14	