



aerospace  
climate control  
electromechanical  
filtration  
fluid & gas handling  
hydraulics  
pneumatics  
process control  
sealing & shielding



# Hydraulic Hoses, Fittings and Equipment

Low pressure



ENGINEERING YOUR SUCCESS.

# Low-Pressure Push-Lok®

The self-grip hose system for low-pressure applications

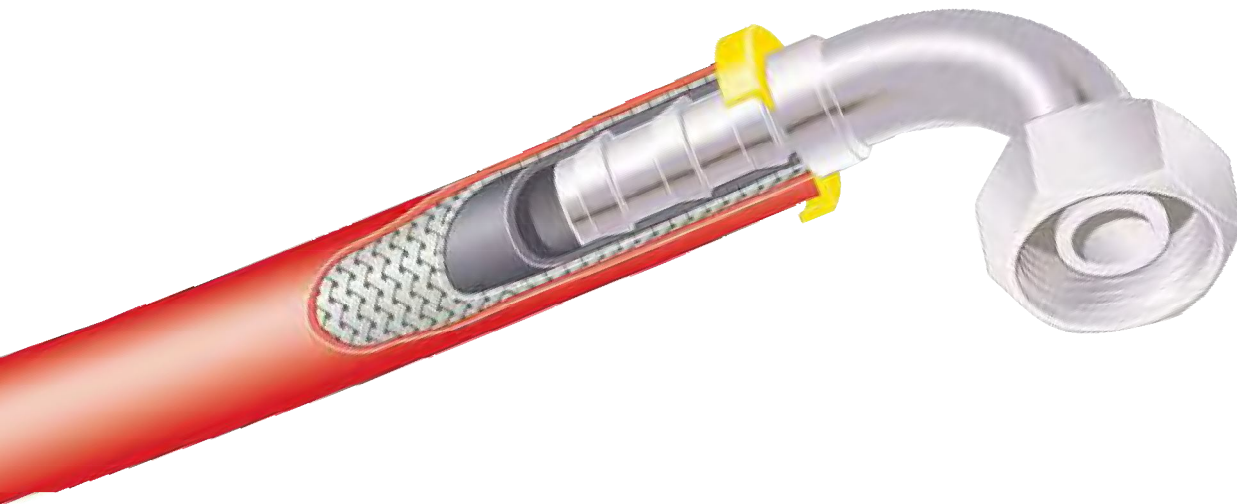

## One fitting series for all hose types

with DIN, BSP, SAE, JIC and ORFS connections in brass, steel and stainless steel



## Wide variety of hose types

6 rubber hose types

- 801Plus** for a variety of applications
- 804** for high-temperature water/phosphate ester fluids
- 821FR** with fire-retardant hose cover
- 831** ideal for petroleum-based fluids
- 836** for high oil temperatures
- 837BM** for a variety of applications including automotive

2 thermoplastic hose types

- 830M** for a variety of applications including automotive
- 838M** for non-conductive applications

1 hybrid hose type

- 837PU-Plus** for a variety of applications including automotive

## Applications

Push-Lok® hoses offer variety, excellent performance and durability for the following applications



## 8 different colours

- easy identification
- simple production processes
  - one colour for one particular medium
- easy control of maintenance intervals
- simple stock planning in different departments



## Easy assembly – no tools or clamps required

### Push-Lok® assembly (1a, b)

- Cut the hose with a sharp knife
- Push the nipple into the hose – that's all!



### Push-Lok® disassembly (2a, b)

- Cut lengthwise along a line at approximately a 20° angle from the centre line of the hose. The cut should be approximately 2 cm long. Be careful not to nick barbs when cutting the hose.
- Grip hose and give a sharp downward tug to disengage from fitting.
- Before re-using the nipple, please check it for any damage.





# Push-Lok® Hoses and Fittings

Low pressure	Push-Lok	Hose	<b>801Plus</b>	B1a-1
			<b>804</b>	B1a-2
			<b>821FR</b>	B1a-3
			<b>830M</b>	B1a-4
			<b>831</b>	B1a-5
			<b>836</b>	B1a-6
			<b>837BM</b>	B1a-7
			<b>837PU</b>	B1a-8
			<b>838M</b>	B1a-9
	Fittings 82 series	<b>DIN - Metric</b>	B1b-1 – B1b-8	
		<b>BSP</b>	B1b-9 – B1b-11	
		<b>SAE</b>	B1b-12 – B1b-15	
		<b>ORFS</b>	B1b-16	
		<b>Others</b>	B1b-17 – B1b-21	
	Assembly Instructions			B1b-22
	Assembly Tools			B1b-22

## Multipurpose

**801** B1a-1



**Push-Lok Plus**  
For a variety of applications

**830M** B1a-4



**Push-Lok**  
For a variety of applications  
including automotive

**831** B1a-5



**Push-Lok**  
Ideal for petroleum based fluids

**837BM** B1a-7



**Push-Lok**  
For a variety of applications  
including automotive

**837PU-Plus** B1a-8



**Hybrid Push-Lok**  
For a variety of applications  
including automotive

## Phosphate Ester

**804** B1a-2



**Push-Lok**  
For high temperature  
water and phosphate ester fluid

## Fire retardant

**821FR** B1a-3



**Push-Lok**  
With fire retardant hose cover

## High temperature

**836** B1a-6



**Push-Lok**  
For high oil temperatures

## Non-conductive

**838M** B1a-9



**Push-Lok**  
For non-conductive applications

# 801

## Push-Lok Plus

For a variety of applications

### Primary Applications

All Markets: For light applications  
Paper and Pulp: For water / air applications

### Restrictions

Not permitted for use in air brake systems.  
Not suitable for high dynamic pulsation systems.  
Not recommended for fuels (petrol, diesel etc.).  
Not recommended for mineral based hydraulic and lubricating oils.

### Construction

Tube: Synthetic rubber  
Reinforcement: High tensile textile layer  
Cover: High performance synthetic rubber in different colours

Temperature Range ..... -40 °C up to +100 °C

Exception: Air ..... max. +70 °C  
Water ..... max. +85 °C



- Very flexible
- Wide range of colours
- Available up to size -16

### Recommended Fluids

Air, dry air, water, water-oil-emulsions and water-glycol-emulsions.

Consult the chemical compatibility section on pages **Ab-22** to **Ab-30** for more detailed information.

### Fitting Series



Part Number	Hose I.D.				Hose O.D.		Pressure Rating				Vaccum kilo Pascal *1 kPa	min. bend radius mm	weight kg
	DN	Inch	Size	mm	mm	max. dynamic working pressure		min. burst pressure					
						MPa	psi	MPa	psi				
801-4-XXX-RL	6	1/4	-4	6.3	12.7	2.4	350	9.7	1400	95	65	0.13	
801-6-XXX-RL	10	3/8	-6	9.5	15.9	2.4	350	9.7	1400	95	75	0.16	
801-8-XXX-RL	12	1/2	-8	12.7	19.8	2.1	300	8.4	1200	95	125	0.27	
801-10-XXX-RL	16	5/8	-10	15.9	23.0	2.1	300	8.4	1200	51	150	0.28	
801-12-XXX-RL	20	3/4	-12	19.1	26.2	2.1	300	8.4	1200	51	180	0.36	
801-16-XXX-RL	25	1	-16	25.4	32.5	1.4	200	5.6	800	51	250	0.55	

\*1 = the vacuum values listed in the table are vacuum pressure values in kPa. For an absolute value subtract the table value from 101 kPa

Note: when ordering, specify Push-Lok hose part number, followed by size, followed by colour. Example: 801-4-XXX-RL

XXX = BLK = black  
BLU = blue  
RED = red  
GRN = green  
GRA = grey  
WHT = white  
YEL = yellow



Example: 801-4-GRN-RL (green)

RL = only available on reels

801-16-XXX-RL is only available in grey or black

# 804

## Push-Lok

For high temperature water and phosphate ester fluid

### Primary Applications

Injection Moulding: For special tempering circuits.

### Restrictions

Not permitted for use in air brake systems.  
Not suitable for high dynamic pulsation systems.  
Do not allow tube to contact any petroleum based fluids.

### Construction

Tube: EPDM material  
Reinforcement: High tensile textile layer  
Cover: Black EPDM material

Temperature Range ..... up to +80 °C  
Exception: Air ..... max. +70 °C  
Water ..... max. +93 °C



- For hot water up to +93 °C
- For phosphate ester fluids

### Recommended Fluids

Phosphate ester based hydraulic fluids, water, water glycol emulsions, air. Use liquid soap as lubricant. Consult the chemical compatibility section on pages **Ab-22** to **Ab-30** for more detailed information.

### Fitting Series



Part Number	Hose I.D.				Hose O.D. mm	Pressure Rating				Vaccum kilo Pascal *1 kPa	min. bend radius mm	weight kg
	DN	Inch	Size	mm		max. dynamic working pressure		min. burst pressure				
						MPa	psi	MPa	psi			
804-4-RL	6	1/4	-4	6.3	12.7	0.9	125	3.4	500	65	0.13	0.13
804-6-RL	10	3/8	-6	9.5	15.9	0.9	125	3.4	500	75	0.16	0.16
804-8-RL	12	1/2	-8	12.7	19.8	0.9	125	3.4	500	130	0.27	0.27
804-12-RL	20	3/4	-12	19.1	26.2	0.9	125	3.4	500	180	0.36	0.28

RL = only available on reels



# 821FR

## Push-Lok

With fire retardant hose cover



- Fire retardant hose cover
- Very flexible
- For high level air temperatures

### Primary Applications

All Markets: For a variety of applications

### Restrictions

Not permitted for use in air brake systems.  
Not suitable for high dynamic pulsation systems.  
Not recommended for fuels (petrol, diesel etc.)

### Construction

Tube: Synthetic PKR-rubber  
Reinforcement: High tensile textile layer  
Cover: A fire retardant special fiber outer cover

Temperature Range ..... -40 °C up to +100 °C

Exception: Air ..... max. +100 °C  
Water ..... max. +85 °C

### Recommended Fluids

Mineral based hydraulic and lubricating oils, coolant, antifreeze, air, water and water-oil emulsions.  
Consult the chemical compatibility section on pages **Ab-22** to **Ab-30** for more detailed information.

### Fitting Series



Part Number	Hose I.D.				Hose O.D.		Pressure Rating				Vaccum kilo Pascal *1 kPa	min. bend radius mm	weight kg
	DN	Inch	Size	mm	mm	max. dynamic working pressure		min. burst pressure					
						MPa	psi	MPa	psi				
821FR-4-XXX-RL	6	1/4	-4	6.3	12.7	2.4	350	9.7	1400	95	65	0.12	
821FR-6-XXX-RL	10	3/8	-6	9.5	15.9	2.0	300	8.3	1200	95	75	0.16	
821FR-8-XXX-RL	12	1/2	-8	12.7	19.8	2.0	300	8.3	1200	95	130	0.18	
821FR-12-XXX-RL	20	3/4	-12	19.0	26.2	1.7	250	6.8	1000	95	180	0.33	

\*1 = the vacuum values listed in the table are vacuum pressure values in kPa. For an absolute value subtract the table value from 101 kPa  
Note: when ordering, specify Push-Lok hose part number, followed by size, followed by colour. Example: 821FR-4-XXX-RL

XXX = BLK = black  
BLU = blue  
GRN = green  
WHT = white  
BRN = brown



Example: 821FR-4-GRN-RL (green)  
RL = only available on reels

# 830M

## Push-Lok

For a variety of applications including automotive

### Primary Applications

All Markets: For a variety of applications  
Robot and Automotive market:  
For hose bundle systems

### Restrictions

Not permitted for use in air brake systems.  
Not suitable for high dynamic pulsation systems.  
Not recommended for fuels (petrol, diesel etc.)

### Construction

Tube: Polyurethane material  
Reinforcement: High tensile textile layer  
Cover: High performance polyurethane material in different colours

Temperature Range ..... -40 °C up to +80 °C



- Chemical resistant for a wide range of fluids
- High abrasion resistance
- Free of wetting disturbing substances (LABS free)
- Small OD and bend radii
- Excellent UV and ozone resistance

### Recommended Fluids

Mineral based hydraulic and lubricating oils, coolant, antifreeze, air, water and water-oil emulsions.  
Consult the chemical compatibility section on pages **Ab-22** to **Ab-30** for more detailed information.

### Fitting Series



Part Number	Hose I.D.				Hose O.D. mm	Pressure Rating				Vacuum kilo Pascal *1 kPa	min. bend radius mm	weight kg
	DN	Inch	Size	mm		max. dynamic working pressure		min. burst pressure				
						MPa	psi	MPa	psi			
830M-4-XXX-RL	6	1/4	-4	6.3	10.7	1.6	232	6.4	928	10	30	0.08
830M-6-XXX-RL	10	3/8	-6	9.5	14.9	1.6	232	6.4	928	10	50	0.13
830M-8-XXX-RL	12	1/2	-8	12.7	19.1	1.6	232	6.4	928	10	70	0.20
830M-10-XXX-RL	16	5/8	-10	16.0	23.0	1.6	232	6.4	928	10	90	0.26
830M-12-XXX-RL	20	3/4	-12	19.0	26.0	1.6	232	6.4	928	10	110	0.31

\*1 = the vacuum values listed in the table are vacuum pressure values in kPa. For an absolute value subtract the table value from 101 kPa

Note: when ordering, specify Push-Lok hose part number, followed by size, followed by colour. Example: 830M-4-XXX-RL

XXX = BLK = black  
BLU = blue  
RED = red  
GRN = green



Example: 830M-4-GRN-RL (green)  
RL = only available on reels

# 831

## Push-Lok

Ideal for petroleum based fluids

### Primary Applications

All Markets: For a wide range of fluids

### Restrictions

Not permitted for use in air brake systems.  
Not suitable for high dynamic pulsation systems.  
Not recommended for fuels (petrol, diesel etc.)

### Construction

Tube: Nitrile (NBR)  
Reinforcement: High tensile textile layer  
Cover: High performance synthetic rubber  
in different colours

Temperature Range ..... -40 °C up to +100 °C

Exception: Air ..... max. +70 °C  
Water ..... max. +85 °C



- Max. working pressure up to 2.4 MPa
- High temperature level for petroleum based fluids
- Nitrile (NBR) inner tube – extended fluid compatibility

### Recommended Fluids

Mineral based hydraulic and lubricating oils, coolant, antifreeze, air, water and water-oil emulsions.  
Consult the chemical compatibility section on pages **Ab-22** to **Ab-30** for more detailed information.

### Fitting Series



Part Number	Hose I.D.				Hose O.D.		Pressure Rating				Vaccum kilo Pascal *1 kPa	min. bend radius mm	weight kg
	DN	Inch	Size	mm	mm	max. dynamic working pressure		min. burst pressure					
						MPa	psi	MPa	psi				
831-4-XXX-RL	6	1/4	-4	6.3	12.7	2.4	350	9.7	1400	95	65	0.13	
831-6-XXX-RL	10	3/8	-6	9.5	15.9	2.0	300	8.3	1200	95	75	0.16	
831-8-XXX-RL	12	1/2	-8	12.7	19.8	2.0	300	8.3	1200	95	130	0.27	
831-10-XXX-RL	16	5/8	-10	15.9	23.0	2.0	300	8.3	1200	51	150	0.28	
831-12-XXX-RL	20	3/4	-12	19.1	26.2	2.0	300	8.3	1200	51	180	0.36	

\*1 = the vacuum values listed in the table are vacuum pressure values in kPa. For an absolute value subtract the table value from 101 kPa  
Note: when ordering, specify Push-Lok hose part number, followed by size, followed by colour. Example: 831-4-XXX-RL

XXX = BLK = black  
BLU = blue  
RED = red  
GRN = green



Example: 831-4-GRN-RL (green)  
RL = only available on reels

# 836

## Push-Lok

For high oil temperatures

### Primary Applications

All Markets: Special high temperature applications

### Type Approvals

Details please find on pages **Ab-14** and **Ab-15**

### Restrictions

Not permitted for use in air brake systems.  
Not suitable for high dynamic pulsation systems.  
Not recommended for fuels (petrol, diesel etc.)

### Construction

Tube: Synthetic PKR rubber  
Reinforcement: High tensile textile layer  
Cover: Blue synthetic PKR rubber

Temperature Range ..... -48 °C up to +150 °C

Exception: Air ..... max. +100 °C

Water ..... max. +85 °C



- Max. oil temperature up to +150 °C
- Blue hose cover

### Recommended Fluids

Mineral based hydraulic and lubricating oils, coolant, antifreeze, air, water and water-oil emulsions.  
Consult the chemical compatibility section on pages **Ab-22** to **Ab-30** for more detailed information.

### Fitting Series



Part Number	Hose I.D.				Hose O.D. mm	Pressure Rating				Vacuum kilo Pascal *1 kPa	min. bend radius mm	weight kg
	DN	Inch	Size	mm		max. dynamic working pressure		min. burst pressure				
						MPa	psi	MPa	psi			
836-4-RL	6	1/4	-4	6.3	12.7	1.7	250	6.8	1000	95	65	0.13
836-6-RL	10	3/8	-6	9.5	15.7	1.7	250	6.8	1000	95	75	0.16
836-8-RL	12	1/2	-8	12.7	19.8	1.7	250	6.8	1000	95	130	0.27
836-10-RL	16	5/8	-10	15.9	23.1	1.7	250	6.8	1000	51	150	0.28
836-12-RL	20	3/4	-12	19.1	26.2	1.7	250	6.8	1000	51	180	0.36

\*1 = the vacuum values listed in the table are vacuum pressure values in kPa. For an absolute value subtract the table value from 101 kPa  
RL = only available on reels

# 837BM

## Push-Lok

For a variety of applications including automotive

### Primary Applications

All Markets: For a variety of applications  
Automotive: For water / air applications

### Restrictions

Not permitted for use in air brake systems  
Not suitable for high dynamic pulsation systems  
Not recommended for fuels (petrol, diesel etc.)  
Not recommended for mineral based hydraulic and lubricating oils

### Construction

Tube: Synthetic rubber  
Reinforcement: High tensile textile layer  
Cover: High performance synthetic rubber in different colours

Temperature Range ..... -40 °C up to +100 °C

Exception: Air ..... max. +70 °C  
Water ..... max. +85 °C



- High level of hose flexibility
- High abrasion resistance
- Free from wetting disturbing substances
- Low push-in forces

### Recommended Fluids

Air, dry air, water, water-oil-emulsions and water-glycol-emulsions.

Consult the chemical compatibility section on pages **Ab-22** to **Ab-30** for more detailed information.

### Fitting Series



Part Number	Hose I.D.				Hose O.D.		Pressure Rating				Vaccum kilo Pascal *1 kPa	min. bend radius mm	weight kg
	DN	Inch	Size	mm	mm	max. dynamic working pressure		min. burst pressure					
						MPa	psi	MPa	psi				
837BM-4-XXX-RL	6	1/4	-4	6.3	12.7	1.6	235	6.4	940	95	65	0.13	
837BM-6-XXX-RL	10	3/8	-6	9.5	15.9	1.6	235	6.4	940	95	75	0.16	
837BM-8-XXX-RL	12	1/2	-8	12.7	19.8	1.6	235	6.4	940	95	130	0.27	
837BM-10-XXX-RL	16	5/8	-10	15.9	23.0	1.6	235	6.4	940	51	150	0.28	
837BM-12-XXX-RL	20	3/4	-12	19.1	26.2	1.6	235	6.4	940	51	180	0.36	
837BM-16-XXX-RL	25	1	-16	25.4	32.5	1.4	200	5.6	800	51	250	0.55	

\*1 = the vacuum values listed in the table are vacuum pressure values in kPa. For an absolute value subtract the table value from 101 kPa  
Note: when ordering, specify Push-Lok hose part number, followed by size, followed by colour. Example: 837BM-4-XXX-RL

XXX = BLK = black  
BLU = blue  
RED = red  
GRN = green  
GRA = grey



Example: 837BM-4-GRN-RL (green)  
RL = only available on reels

# 837PU-Plus

## Hybrid Push-Lok

For a variety of applications including automotive

### Primary Applications

- All Markets: For high demand applications  
For energy chain systems
- Robot and Automotive market:  
For hose bundle systems

### Restrictions

- Not permitted for use in air brake systems  
Not suitable for high dynamic pulsation systems  
Not recommended for fuels (petrol, diesel etc.)  
Not recommended for mineral based hydraulic and lubricating oils

### Construction

- Tube: Synthetic rubber  
Reinforcement: High tensile textile layer  
Cover: High performance polyurethane material in different colours

Temperature Range ..... -40 °C up to +100 °C

- Exception: Air ..... max. +70 °C  
Water ..... max. +85 °C



- High level of hose flexibility
- High abrasion resistance
- High torsion resistance
- Free from wetting disturbing substances
- Low push-in forces

### Recommended Fluids

Air, dry air, water, water-oil-emulsions and water-glycol-emulsions.  
Consult the chemical compatibility section on pages **Ab-22** to **Ab-30** for more detailed information.

### Fitting Series



Part Number	Hose I.D.				Hose O.D. mm	Pressure Rating				Vacuum kilo Pascal *1 kPa	min. bend radius mm	weight kg
	DN	Inch	Size	mm		max. dynamic working pressure		min. burst pressure				
						MPa	psi	MPa	psi			
837PU-4-xxx-RL	6	1/4	-4	6.3	12.7	1.6	235	6.4	940	95	30	0.11
837PU-6-xxx-RL	10	3/8	-6	9.5	15.9	1.6	235	6.4	940	95	50	0.15
837PU-8-xxx-RL	12	1/2	-8	12.7	19.8	1.6	235	6.4	940	95	70	0.26
837PU-10-xxx-RL	16	5/8	-10	15.9	23.0	1.6	235	6.4	940	51	90	0.27
837PU-12-xxx-RL	20	3/4	-12	19.1	26.2	1.6	235	6.4	940	51	110	0.33

\*1 = the vacuum values listed in the table are vacuum pressure values in kPa. For an absolute value subtract the table value from 101 kPa  
Note: when ordering, specify Push-Lok hose part number, followed by size, followed by colour. Example: 837PU-4-XXX-RL

- XXX = BLK = black  
BLU = blue  
RED = red  
GRN = green  
GRA = grey



Example: 837PU-4-GRN-RL (green)  
RL = only available on reels

# 838M

## Push-Lok

For non-conductive applications



- Non conductive hose
- High level of hose flexibility

### Primary Applications

Special Market: For special electrical requirements,  
e.g. cooling lines with de-ionized water

### Restrictions

Not permitted for use in air brake systems.  
Not suitable for high dynamic pulsation systems.  
Not recommended for fuels (petrol, diesel etc.)

### Construction

Tube: Polyurethane material  
Reinforcement: High tensile textile layer  
Cover: Orange coloured polyurethane material

Temperature Range ..... -40 °C up to +80 °C

### Recommended Fluids

Mineral based hydraulic and lubricating oils, coolant,  
antifreeze, water, water-oil emulsions.  
Consult the chemical compatibility section on  
pages **Ab-22** to **Ab-30** for more detailed information.









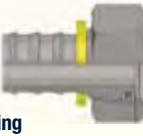

### Fitting Series

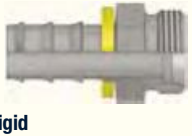





Part Number	Hose I.D.				Hose O.D. mm	Pressure Rating				Vacuum kilo Pascal *1 kPa	min. bend radius mm	weight kg
	DN	Inch	Size	mm		max. dynamic working pressure		min. burst pressure				
						MPa	psi	MPa	psi			
838M-4-RL	6	1/4	-4	6.3	11.2	1.6	232	6.4	928	10	30	0.08
838M-6-RL	10	3/8	-6	9.5	15.0	1.6	232	6.4	928	10	50	0.13
838M-8-RL	12	1/2	-8	12.7	19.1	1.6	232	6.4	928	10	70	0.20
838M-10-RL	16	5/8	-10	16.0	23.0	1.6	232	6.4	928	10	90	0.26
838M-12-RL	20	3/4	-12	19.0	26.0	1.6	232	6.4	928	10	110	0.31

\*1 = the vacuum values listed in the table are vacuum pressure values in kPa. For an absolute value subtract the table value from 101 kPa  
RL = only available on reels



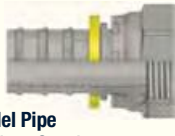

## DIN – Metric

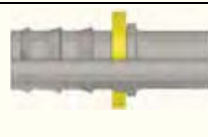
Page B1b-1 – B1b-8			
<p><b>CA</b> B1b-1</p>  <p>Female Metric 24° Light Series with O-Ring Swivel – Straight ISO 12151-2-SWS-L – DKOL</p>	<p><b>CE</b> B1b-1</p>  <p>Female Metric 24° Light Series with O-Ring Swivel – 45° Elbow ISO 12151-2-SWE 45°-L – DKOL 45°</p>	<p><b>CF</b> B1b-2</p>  <p>Female Metric 24° Light Series with O-Ring Swivel – 90° Elbow ISO 12151-2-SWE-L – DKOL 90°</p>	<p><b>D0</b> B1b-2</p>  <p>Male Metric 24° Light Series – Rigid Straight ISO 12151-2-S-L – CEL</p>
<p><b>C3</b> B1b-3</p>  <p>Female Metric Light Series – Swivel Straight (Ball Nose) DKL</p>	<p><b>C4</b> B1b-4</p>  <p>Female Metric Light Series – Swivel 45° Elbow (Ball Nose) DKL 45°</p>	<p><b>C5</b> B1b-5</p>  <p>Female Metric Light Series – Swivel 90° Elbow (Ball Nose) DKL 90°</p>	<p><b>1D</b> B1b-6</p>  <p>Metric Standpipe Light Series – Rigid Straight ISO 8434-1 – BEL</p>
<p><b>49</b> B1b-7</p>  <p>Metric Banjo Straight DIN 7642</p>	<p><b>9B</b> B1b-8</p>  <p>Female Metric Swivel Light Series 45° Elbow</p>	<p><b>9C</b> B1b-8</p>  <p>Female Metric Swivel Light Series 90° Elbow</p>	

## BSP

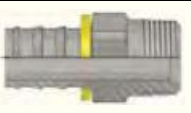
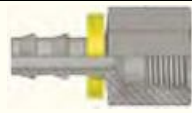
Page B1b-9 – B1b-11			
<p><b>92</b> B1b-9</p>  <p>Female BSP Parallel Pipe Swivel – Straight (60° Cone) BS5200-A – DKR</p>	<p><b>B1</b> B1b-9</p>  <p>Female BSP Parallel Pipe Swivel 45° Elbow (60° Cone) BS 5200-D – DKR 45°</p>	<p><b>B2</b> B1b-10</p>  <p>Female BSP Parallel Pipe Swivel 90° Elbow (60° Cone) BS 5200-B – DKR 90°</p>	<p><b>D9</b> B1b-10</p>  <p>Male BSP Parallel Pipe Rigid – Straight (60° Cone) BS5200 – AGR</p>
<p><b>91</b> B1b-11</p>  <p>Male BSP Taper Pipe – Rigid Straight BS5200 – AGR-K</p>	<p><b>34</b> B1b-11</p>  <p>Inch Standpipe (Brass)</p>		

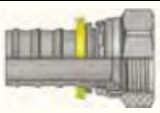
## SAE

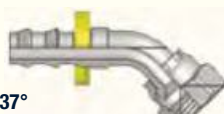
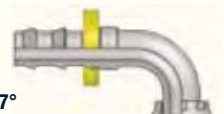





Page B1b-12 – B1b-15			
<p><b>01</b> B1b-12</p>  <p>Male NPTF Pipe Rigid – Straight SAE J476A / J516 – AGN</p>	<p><b>02</b> B1b-12</p>  <p>Female NPTF Pipe – Rigid Straight SAE J476A / J516</p>	<p><b>03</b> B1b-13</p>  <p>Male JIC 37° – Rigid Straight ISO12151-5-S – AGJ</p>	<p><b>06/68</b> B1b-13</p>  <p>Female – JIC 37° SAE 45° Dual Flare Swivel – Straight ISO12151-5-SWS – DKJ</p>
<p><b>08</b> B1b-14</p>  <p>Female SAE 45° – Swivel Straight SAE J516</p>	<p><b>37/3V</b> B1b-15</p>  <p>Female JIC 37° SAE 45° – Dual Flare Swivel Female 45° Elbow ISO 12151-5-SWE 45° – DKJ 45°</p>	<p><b>39/3W</b> B1b-15</p>  <p>Female JIC 37° SAE 45° – Dual Flare Swivel Female 90° Elbow ISO 12151-5-SWES – DKJ 90°</p>	

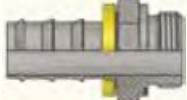

# ORFS

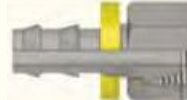
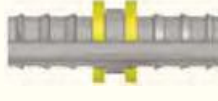
<b>Page B1b-16</b>	
<p><b>JC</b> <b>B1b-16</b> Female ORFS Swivel – Straight Short ISO 12151-1 – SWSA SAE J516 – ORFS</p>	

# Others

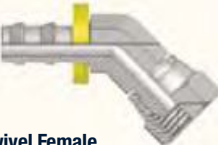
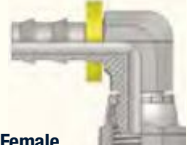
<b>Page B1b-17 – B1b-21</b>			
<p><b>FF</b> <b>B1b-17</b></p>  <p>Metru-Lok Swivel Female</p>	<p><b>AF</b> <b>B1b-17</b></p>  <p>Male BSP Parallel Pipe Rigid – Straight (with O-ring Seal)</p>	<p><b>NM</b> <b>B1b-18</b></p>  <p>Male BSP Parallel Pipe L Series – Rigid – Straight ED-Seal ISO 1179</p>	<p><b>VW121</b> <b>B1b-18</b></p>  <p>BSP Swivel Female (VW-Norm 39-V-16631)</p>
<p><b>82</b> <b>B1b-19</b></p>  <p>Push-Lok® Union</p>	<p><b>DP</b> <b>B1b-19</b></p>  <p>Metric Swivel Female Tee Male Stud</p>	<p><b>DR</b> <b>B1b-20</b></p>  <p>Metric Swivel Female Tee</p>	<p><b>5C</b> <b>B1b-20</b></p>  <p>60° Cone Swivel Female</p>
<p><b>6C</b> <b>B1b-21</b></p>  <p>60° Cone Swivel Female 45° Elbow</p>	<p><b>7C</b> <b>B1b-21</b></p>  <p>60° Cone Swivel Female 90° Elbow</p>		



# CA

## Female Metric 24° Light Series with O-Ring Swivel – Straight

ISO 12151-2-SWS-L – DKOL

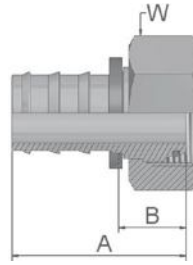

XXXXX-XX-XX Part Number 	Hose I.D.				Thread metric	Tube O.D. mm	A mm	B mm	W mm
	DN	Inch	Size	mm					
3CA82-6-4	6	1/4	-4	6.3	M12x1.5	6	40	21	14
3CA82-6-4B	6	1/4	-4	6.3	M12x1.5	6	40	21	14
3CA82-8-4	6	1/4	-4	6.3	M14x1.5	8	36	17	17
3CA82-8-4B	6	1/4	-4	6.3	M14x1.5	8	36	17	17
3CA82-10-4	6	1/4	-4	6.3	M16x1.5	10	36	17	19
3CA82-10-6	10	3/8	-6	9.5	M16x1.5	10	40	17	19
3CA82-10-6B	10	3/8	-6	9.5	M16x1.5	10	39	17	19
3CA82-12-6	10	3/8	-6	9.5	M18x1.5	12	40	17	22
3CA82-12-6B	10	3/8	-6	9.5	M18x1.5	12	39	17	22
3CA82-15-8	12	1/2	-8	12.7	M22x1.5	15	44	18	27
3CA82-15-8B	12	1/2	-8	12.7	M22x1.5	15	44	17	27
3CA82-15-10B	16	5/8	-10	15.9	M22x1.5	15	60	23	27
3CA82-18-10	16	5/8	-10	15.9	M26x1.5	18	56	19	32
3CA82-22-12	20	3/4	-12	19.1	M30x2	22	58	21	36
3CA82-22-12B	20	3/4	-12	19.1	M30x2	22	58	21	36

Fittings with standard O-ring seals can be used for temperatures from -30 °C up to +105 °C.

# CE

## Female Metric 24° Light Series with O-Ring Swivel – 45° Elbow

ISO 12151-2-SWE 45°-L – DKOL 45°

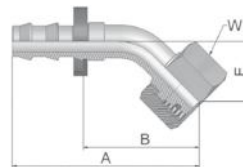

XXXXX-XX-XX Part Number 	Hose I.D.				Thread metric	Tube O.D. mm	A mm	B mm	E mm	W mm
	DN	Inch	Size	mm						
3CE82-6-4	6	1/4	-4	6.3	M12x1.5	6	56	37	21	14
3CE82-8-4	6	1/4	-4	6.3	M14x1.5	8	51	31	16	17
3CE82-10-6	10	3/8	-6	9.5	M16x1.5	10	59	37	19	19
3CE82-12-6	10	3/8	-6	9.5	M18x1.5	12	60	37	19	22
3CE82-15-8	12	1/2	-8	12.7	M22x1.5	15	69	43	21	27
3CE82-18-10	16	5/8	-10	15.9	M26x1.5	18	83	46	23	32
3CE82-22-12	20	3/4	-12	19.1	M30x2	22	97	60	26	36

Fittings with standard O-ring seals can be used for temperatures from -30 °C up to +105 °C.

Also available in stainless steel. Details can be found in CAT 4400.1/UK

Approved fitting series for hose types:

B: Brass; K: Without plastic ring; SM: Metric Hexagon

 801 804 821FR 830M 831 836 837BM 837PU 838M

## CF Female Metric 24° Light Series with O-Ring Swivel – 90° Elbow

ISO 12151-2-SWE-L – DKOL 90°

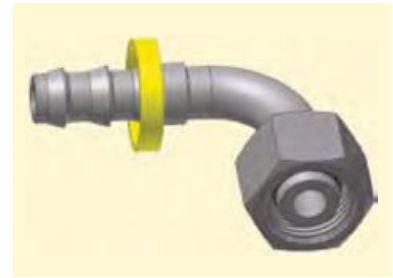
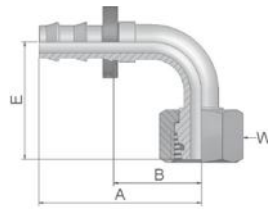



XXXXX-XX-XX Part Number 	Hose I.D.				Thread metric	Tube O.D. mm	A mm	B mm	E mm	W mm
	DN	Inch	Size	mm						
3CF82-6-4	6	1/4	-4	6.3	M12x1.5	6	42	23	36	14
3CF82-8-4	6	1/4	-4	6.3	M14x1.5	8	41	23	29	17
3CF82-10-4	6	1/4	-4	6.3	M16x1.5	10	42	23	31	19
3CF82-10-6	10	3/8	-6	9.5	M16x1.5	10	49	27	35	19
3CF82-10-6B	10	3/8	-6	9.5	M16x1.5	10	49	27	35	19
3CF82-12-6	10	3/8	-6	9.5	M18x1.5	12	49	27	35	22
3CF82-12-6B	10	3/8	-6	9.5	M18x1.5	12	49	27	35	22
3CF82-15-8	12	1/2	-8	12.7	M22x1.5	15	60	34	41	27
3CF82-15-8B	12	1/2	-8	12.7	M22x1.5	15	60	34	41	27
3CF82-18-10	16	5/8	-10	15.9	M26x1.5	18	74	37	45	32
3CF82-22-12	20	3/4	-12	19.1	M30x2	22	83	46	55	36

Fittings with standard O-ring seals can be used for temperatures from -30 °C up to +105 °C.  
Special O-rings are available on request.

## DO Male Metric 24° Light Series – Rigid Straight

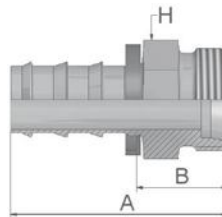
ISO 12151-2-S-L – CEL



XXXXX-XX-XX Part Number 	Hose I.D.				Thread metric	Tube O.D. mm	A mm	B mm	H mm
	DN	Inch	Size	mm					
3D082-6-4	6	1/4	-4	6.3	M12x1.5	6	35	16	12
3D082-8-4	6	1/4	-4	6.3	M14x1.5	8	36	17	14
3D082-8-4B	6	1/4	-4	6.3	M14x1.5	8	36	17	14
3D082-10-6	10	3/8	-6	9.5	M16x1.5	10	41	18	17
3D082-10-6B	10	3/8	-6	9.5	M16x1.5	10	41	18	17
3D082-12-6	10	3/8	-6	9.5	M18x1.5	12	41	18	19
3D082-12-6B	10	3/8	-6	9.5	M18x1.5	12	41	18	19
3D082-15-8	12	1/2	-8	12.7	M22x1.5	15	49	23	22
3D082-15-8B	12	1/2	-8	12.7	M22x1.5	15	49	22	22
3D082-18-8	12	1/2	-8	12.7	M26x1.5	18	48	21	27
3D082-18-10	16	5/8	-10	15.9	M26x1.5	18	58	21	27
3D082-18-10B	16	5/8	-10	15.9	M26x1.5	18	58	21	27
3D082-22-12	20	3/4	-12	19.1	M30x2	22	63	27	30
3D082-22-12B	20	3/4	-12	19.1	M30x2	22	63	27	30

Also available in stainless steel. Details can be found in CAT 4400.1/UK

Approved fitting series for hose types:





B: Brass; K: Without plastic ring; SM: Metric Hexagon

**82**  801 804 821FR 830M 831 836 837BM 837PU 838M

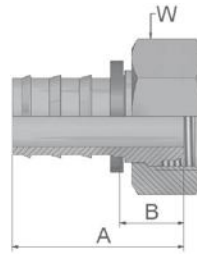
# C3 Female Metric Light Series – Swivel Straight (Ball Nose)

DKL



XXXXX-XX-XX Part Number 	 Hose I.D.				 Thread metric	Tube O.D. mm	A mm	B mm	 W mm
	DN	Inch	Size	mm					
3C382-6-4	6	1/4	-4	6.3	M12x1.5	6	33	14	14
3C382-6-4B	6	1/4	-4	6.3	M12x1.5	6	33	14	14
3C382-8-4	6	1/4	-4	6.3	M14x1.5	8	33	14	17
3C382-8-4B	6	1/4	-4	6.3	M14x1.5	8	36	17	19
3C382-10-4	6	1/4	-4	6.3	M16x1.5	10	34	15	19
3C382-10-6	10	3/8	-6	9.5	M16x1.5	10	37	15	19
3C382-10-6B	10	3/8	-6	9.5	M16x1.5	10	40	17	19
3C382-12-6	10	3/8	-6	9.5	M18x1.5	12	38	16	22
3C382-12-6B	10	3/8	-6	9.5	M18x1.5	12	40	17	22
3C382-15-8	12	1/2	-8	12.7	M22x1.5	15	42	15	27
3C382-15-8B	12	1/2	-8	12.7	M22x1.5	15	46	19	27
3C382-15-10	16	5/8	-10	15.9	M22x1.5	15	56	19	27
3C382-18-10	16	5/8	-10	15.9	M26x1.5	18	53	17	32
3C382-18-10B	16	5/8	-10	15.9	M26x1.5	18	58	22	32
3C382-22-12	20	3/4	-12	19.1	M30x2	22	53	17	36
3C382-22-12B	20	3/4	-12	19.1	M30x2	22	58	22	36
3C382-28-16	25	1	-16	25.4	M36x2	28	58	22	41
3C382-28-16B	25	1	-16	25.4	M36x2	28	58	22	41

Also available in stainless steel. Details can be found in CAT 4400.1/UK

Approved fitting series for hose types:





B: Brass; K: Without plastic ring; SM: Metric Hexagon

 801 804 821FR 830M 831 836 837BM 837PU 838M

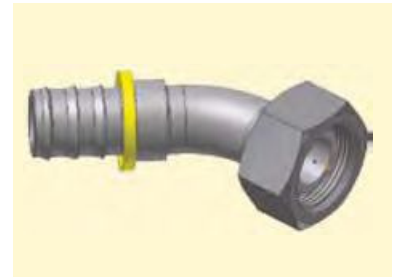
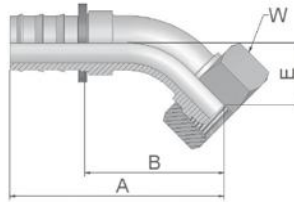
**C4** Female Metric  
Light Series – Swivel  
45° Elbow (Ball Nose)

DKL 45°



XXXXX-XX-XX Part Number 	 Hose I.D.				 Thread metric	Tube O.D. mm	A mm	B mm	E mm	 W mm
	DN	Inch	Size	mm						
3C482-6-4	6	1/4	-4	6.3	M12x1.5	6	51	32	16	14
3C482-6-4B	6	1/4	-4	6.3	M12x1.5	6	51	32	16	14
3C482-8-4	6	1/4	-4	6.3	M14x1.5	8	51	32	16	17
3C482-8-4B	6	1/4	-4	6.3	M14x1.5	8	51	32	16	17
3C482-10-6	10	3/8	-6	9.5	M16x1.5	10	58	35	18	19
3C482-10-6B	10	3/8	-6	9.5	M16x1.5	10	58	35	17	19
3C482-12-6	10	3/8	-6	9.5	M18x1.5	12	59	36	18	22
3C482-12-6B	10	3/8	-6	9.5	M18x1.5	12	58	36	18	22
3C482-15-8	12	1/2	-8	12.7	M22x1.5	15	68	41	19	27
3C482-15-8B	12	1/2	-8	12.7	M22x1.5	15	67	41	19	27
3C482-15-10	16	5/8	-10	15.9	M22x1.5	15	82	45	21	27
3C482-15-10B	16	5/8	-10	15.9	M22x1.5	15	82	45	21	27
3C482-18-10	16	5/8	-10	15.9	M26x1.5	18	81	45	21	32
3C482-18-10B	16	5/8	-10	15.9	M26x1.5	18	81	45	21	32
3C482-18-12	20	3/4	-12	19.1	M26x1.5	18	96	60	26	32
3C482-22-12	20	3/4	-12	19.1	M30x2	22	88	52	23	36

Also available in stainless steel. Details can be found in CAT 4400.1/UK

Approved **fitting series** for hose types:

B: Brass; K: Without plastic ring; SM: Metric Hexagon

**82**  801 804 821FR 830M 831 836 837BM 837PU 838M

# C5 Female Metric Light Series – Swivel 90° Elbow (Ball Nose)

DKL 90°

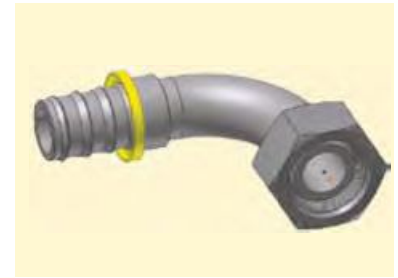
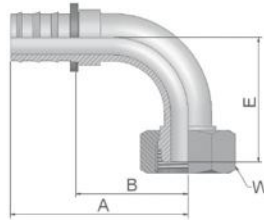

XXXXX-XX-XX Part Number 	Hose I.D.			Thread metric	Tube O.D. mm	A mm	B mm	E mm	W mm	
	DN	Inch	Size							mm
3C582-6-4	6	1/4	-4	6.3	M12x1.5	6	42	23	29	14
3C582-8-4	6	1/4	-4	6.3	M14x1.5	8	42	23	29	17
3C582-8-4B	6	1/4	-4	6.3	M14x1.5	8	41	23	29	17
3C582-10-6	10	3/8	-6	9.5	M16x1.5	10	49	27	33	19
3C582-12-6	10	3/8	-6	9.5	M18x1.5	12	49	27	34	22
3C582-12-6B	10	3/8	-6	9.5	M18x1.5	12	49	27	34	22
3C582-15-8	12	1/2	-8	12.7	M22x1.5	15	60	34	39	27
3C582-15-8B	12	1/2	-8	12.7	M22x1.5	15	58	32	39	27
3C582-18-10	16	5/8	-10	15.9	M26x1.5	18	74	37	43	32
3C582-18-10B	16	5/8	-10	15.9	M26x1.5	18	74	37	43	32
3C582-22-12	20	3/4	-12	19.1	M30x2	22	88	51	50	36
3C582-22-12B	20	3/4	-12	19.1	M30x2	22	88	52	50	36
3C582-28-16B	25	1	-16	25.4	M36x2	28	101	64	66	41

Also available in stainless steel. Details can be found in CAT 4400.1/UK

Approved fitting series for hose types:



B: Brass; K: Without plastic ring; SM: Metric Hexagon

 801 804 821FR 830M 831 836 837BM 837PU 838M

# 1D Metric Standpipe Light Series – Rigid Straight

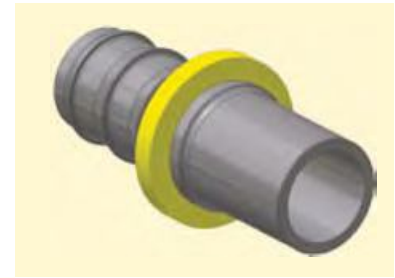
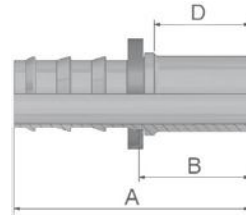
ISO 8434-1 – BEL



XXXXX-XX-XX Part Number 	 Hose I.D.				Tube O.D. mm	A mm	B mm	D mm
	DN	Inch	Size	mm				
31D82-6-4	6	1/4	-4	6.3	6	44	25	22
31D82-6-4B	6	1/4	-4	6.3	6	44	25	22
31D82-8-4	6	1/4	-4	6.3	8	44	25	22
31D82-8-4B	6	1/4	-4	6.3	8	44	25	22
31D82-10-6	10	3/8	-6	9.5	10	49	26	23
31D82-10-6B	10	3/8	-6	9.5	10	49	26	23
31D82-12-6	10	3/8	-6	9.5	12	49	27	23
31D82-12-6B	10	3/8	-6	9.5	12	49	27	23
31D82-15-8	12	1/2	-8	12.7	15	55	29	25
31D82-15-8B	12	1/2	-8	12.7	15	55	29	25
31D82-18-10	16	5/8	-10	15.9	18	67	30	26
31D82-18-10B	16	5/8	-10	15.9	18	67	30	26
31D82-22-12	20	3/4	-12	19.1	22	69	32	28
31D82-22-12B	20	3/4	-12	19.1	22	69	32	28

Attention: For assembly of EO-2-functional nut or nut and progressive ring use the EO-pre-assembly body.

Also available in stainless steel. Details can be found in CAT 4400.1/UK

Approved **fitting series** for hose types:

**B:** Brass; **K:** Without plastic ring; **SM:** Metric Hexagon

 801 804 821FR 830M 831 836 837BM 837PU 838M





49

**Metric Banjo  
Straight**

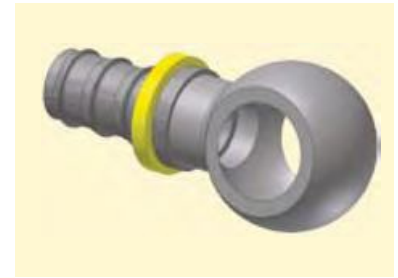
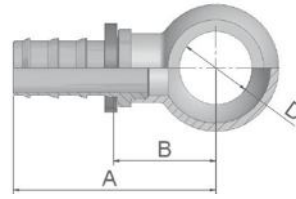
DIN 7642



XXXXX-XX-XX Part Number 	 Hose I.D.				A mm	B mm	D mm
	DN	Inch	Size	mm			
34982-8-4	6	1/4	-4	6.3	36	17	8
34982-10-4	6	1/4	-4	6.3	38	19	10
34982-12-4	6	1/4	-4	6.3	40	21	12
34982-14-4	6	1/4	-4	6.3	42	23	14
34982-10-6	10	3/8	-6	9.5	42	19	10
34982-12-6	10	3/8	-6	9.5	44	21	12
34982-14-6	10	3/8	-6	9.5	47	24	14
34982-16-6	10	3/8	-6	9.5	49	26	16
34982-17-6	10	3/8	-6	9.5	49	26	17
34982-14-8	12	1/2	-8	12.7	51	25	14
34982-18-8	12	1/2	-8	12.7	55	28	18
34982-22-8	12	1/2	-8	12.7	57	31	22
34982-22-10	16	5/8	-10	15.9	68	32	22
34982-26-12	20	3/4	-12	19.1	74	38	26

Also available in stainless steel. Details can be found in CAT 4400.1/UK

Approved **fitting series** for hose types:

B: Brass; K: Without plastic ring; SM: Metric Hexagon

 801 804 821FR 830M 831 836 837BM 837PU 838M

## 9B Female Metric Swivel Light Series 45° Elbow

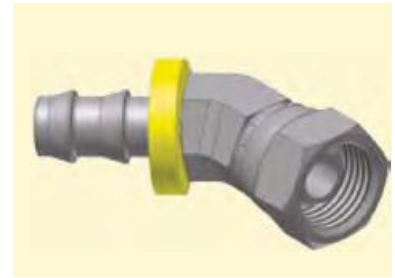
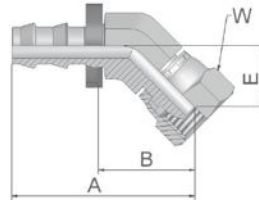

XXXXX-XX-XX Part Number 	Hose I.D.				Thread metric	Tube O.D. mm	A mm	B mm	E mm	W mm
	DN	Inch	Size	mm						
39B82-6-4BK	6	1/4	-4	6.3	M12x1.5	6	44	23	16	14
39B82-8-4BK	6	1/4	-4	6.3	M14x1.5	8	43	23	15	19
39B82-10-6BK	10	3/8	-6	9.5	M16x1.5	10	48	25	16	19
39B82-12-6BK	10	3/8	-6	9.5	M18x1.5	12	50	26	17	22
39B82-15-8BK	12	1/2	-8	12.7	M22x1.5	15	54	26	18	27

## 9C Female Metric Swivel Light Series 90° Elbow

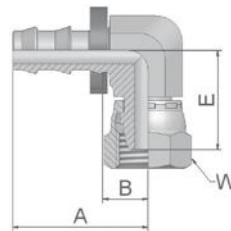

XXXXX-XX-XX Part Number 	Hose I.D.				Thread metric	Tube O.D. mm	A mm	B mm	E mm	W mm
	DN	Inch	Size	mm						
39C82-6-4BK	6	1/4	-4	6.3	M12x1.5	6	30	10	22	14
39C82-8-4BK	6	1/4	-4	6.3	M14x1.5	8	30	10	22	19
39C82-10-6BK	10	3/8	-6	9.5	M16x1.5	10	34	10	25	19
39C82-12-6BK	10	3/8	-6	9.5	M18x1.5	12	34	10	25	22
39C82-15-8BK	12	1/2	-8	12.7	M22x1.5	15	43	15	32	27

Also available in stainless steel. Details can be found in CAT 4400.1/UK

Approved **fitting series** for hose types:

B: Brass; K: Without plastic ring; SM: Metric Hexagon

**82**  801 804 821FR 830M 831 836 837BM 837PU 838M

## 92 Female BSP Parallel Pipe Swivel – Straight (60° Cone)

BS5200-A – DKR

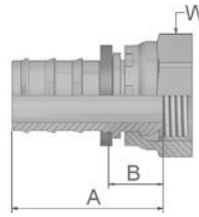

XXXXX-XX-XX Part Number 	Hose I.D.				Thread BSP	A mm	B mm	W mm
	DN	Inch	Size	mm				
39282-4-4	6	1/4	-4	6.3	1/4x19	33	14	17
39282-6-4B	6	1/4	-4	6.3	3/8x19	37	18	22
39282-6-6	10	3/8	-6	9.5	3/8x19	37	14	19
39282-8-8	12	1/2	-8	12.7	1/2x14	42	15	27
39282-8-8B	12	1/2	-8	12.7	1/2x14	46	19	27
39282-10-10	16	5/8	-10	15.9	5/8x14	53	16	30
39282-10-10B	16	5/8	-10	15.9	5/8x14	55	18	30
39282-12-12	20	3/4	-12	19.1	3/4x14	58	21	32
39282-12-12B	20	3/4	-12	19.1	3/4x14	58	21	32
39282-16-16B	25	1	-16	25.4	1x11	74	38	36

## B1 Female BSP Parallel Pipe Swivel 45° Elbow (60° Cone)

BS 5200-D – DKR 45°

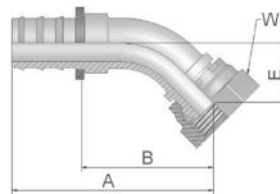

XXXXX-XX-XX Part Number 	Hose I.D.				Thread BSP	A mm	B mm	E mm	W mm
	DN	Inch	Size	mm					
3B182-4-4	6	1/4	-4	6.3	1/4x19	51	32	16	17
3B182-6-6	10	3/8	-6	9.5	3/8x19	58	35	18	19
3B182-6-6B	10	3/8	-6	9.5	3/8x19	58	45	17	19
3B182-8-8	12	1/2	-8	12.7	1/2x14	68	41	19	27
3B182-8-8B	12	1/2	-8	12.7	1/2x14	67	41	19	27
3B182-10-10	16	5/8	-10	15.9	5/8x14	81	45	21	30
3B182-12-12	20	3/4	-12	19.1	3/4x14	92	55	27	32

Also available in stainless steel. Details can be found in CAT 4400.1/UK

Approved fitting series for hose types:

B: Brass; K: Without plastic ring; SM: Metric Hexagon

 801 804 821FR 830M 831 836 837BM 837PU 838M

## B2 Female BSP Parallel Pipe Swivel 90° Elbow (60° Cone)

BS 5200-B – DKR 90°

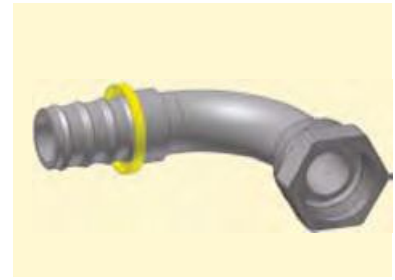
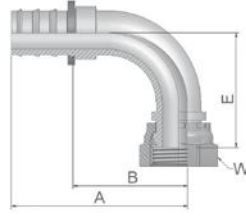

XXXXX-XX-XX Part Number 	Hose I.D.				Thread BSP	A mm	B mm	E mm	W mm
	DN	Inch	Size	mm					
3B282-4-4	6	1/4	-4	6.3	1/4x19	42	23	29	17
3B282-6-6	10	3/8	-6	9.5	3/8x19	49	27	33	19
3B282-6-6B	10	3/8	-6	9.5	3/8x19	49	27	33	19
3B282-8-8	12	1/2	-8	12.7	1/2x14	60	34	39	27
3B282-8-8B	12	1/2	-8	12.7	1/2x14	60	34	39	27
3B282-10-8	12	1/2	-8	12.7	5/8x14	58	32	40	30
3B282-10-10	16	5/8	-10	15.9	5/8x14	74	37	43	30
3B282-10-10B	16	5/8	-10	15.9	5/8x14	74	37	44	30
3B282-12-12	20	3/4	-12	19.1	3/4x14	83	46	53	32
3B282-12-12B	20	3/4	-12	19.1	3/4x14	83	46	53	32

## D9 Male BSP Parallel Pipe Rigid – Straight (60° Cone)

BS5200 – AGR

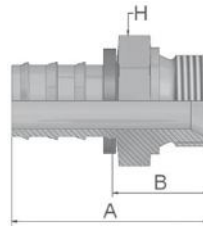

XXXXX-XX-XX Part Number 	Hose I.D.				Thread BSP	A mm	B mm	H mm
	DN	Inch	Size	mm				
3D982-2-4	6	1/4	-4	6.3	1/8x28	36	17	14
3D982-4-4	6	1/4	-4	6.3	1/4x19	41	23	19
3D982-4-4B	6	1/4	-4	6.3	1/4x19	41	23	19
3D982-4-6	10	3/8	-6	9.5	1/4x19	44	21	19
3D982-6-6	10	3/8	-6	9.5	3/8x19	45	23	22
3D982-6-6B	10	3/8	-6	9.5	3/8x19	45	23	22
3D982-8-8	12	1/2	-8	12.7	1/2x14	53	27	27
3D982-8-8B	12	1/2	-8	12.7	1/2x14	53	27	27
3D982-10-10	16	5/8	-10	15.9	5/8x14	65	28	30
3D982-10-10B	16	5/8	-10	15.9	5/8x14	65	28	30
3D982-12-12	20	3/4	-12	19.1	3/4x14	65	28	32
3D982-12-12B	20	3/4	-12	19.1	3/4x14	65	28	32

Also available in stainless steel. Details can be found in CAT 4400.1/UK

Approved fitting series for hose types:

B: Brass; K: Without plastic ring; SM: Metric Hexagon

**82**  801 804 821FR 830M 831 836 837BM 837PU 838M

# 91 Male BSP Taper Pipe – Rigid Straight

BS5200 – AGR-K

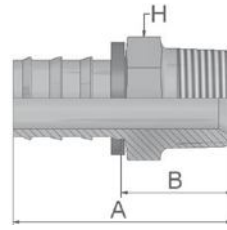

XXXXX-XX-XX Part Number 	Hose I.D.				Thread BSP	A mm	B mm	H mm
	DN	Inch	Size	mm				
39182-2-4B	6	1/4	-4	6.3	1/8x28	37	18	12
39182-4-4B	6	1/4	-4	6.3	1/4x19	40	21	14
39182-4-6B	10	3/8	-6	9.5	1/4x19	44	21	14
39182-6-6B	10	3/8	-6	9.5	3/8x19	45	22	19
39182-6-8B	12	1/2	-8	12.7	3/8x19	49	22	19
39182-8-8B	12	1/2	-8	12.7	1/2x14	55	29	22
39182-8-10B	16	5/8	-10	15.9	1/2x14	65	28	22
39182-12-10B	16	5/8	-10	15.9	3/4x14	69	32	30
39182-12-12B	20	3/4	-12	19.1	3/4x14	69	32	30

# 34 Inch Standpipe (Brass)

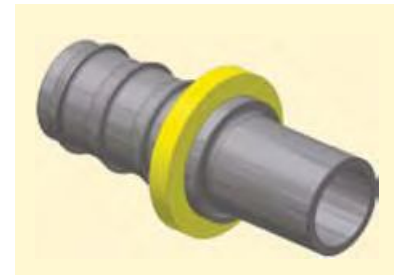
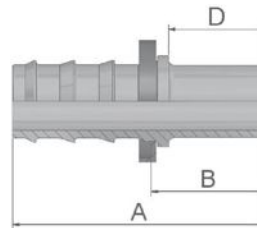

XXXXX-XX-XX Part Number 	Hose I.D.				Tube O.D.	A mm	B mm	D mm
	DN	Inch	Size	mm				
33482-4-4B	6	1/4	-4	6.3	1/4	48	29	26
33482-6-6B	10	3/8	-6	9.5	3/8	57	34	31
33482-8-8B	12	1/2	-8	12.7	1/2	55	28	25
33482-10-10B	16	5/8	-10	15.9	5/8	67	30	25
33482-12-12B	20	3/4	-12	19.1	3/4	67	30	25

Also available in stainless steel. Details can be found in CAT 4400.1/UK

Approved fitting series for hose types:

B: Brass; K: Without plastic ring; SM: Metric Hexagon

 801 804 821FR 830M 831 836 837BM 837PU 838M

# 01 Male NPTF Pipe Rigid – Straight

SAE J476A / J516 – AGN

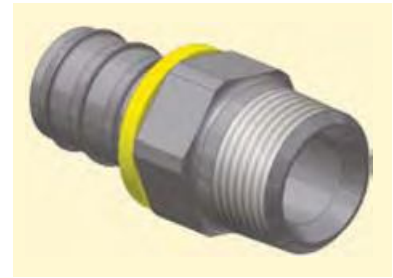
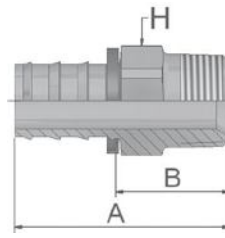

XXXXX-XX-XX Part Number 	Hose I.D.				Thread NPTF	A mm	B mm	H mm Inch
	DN	Inch	Size	mm				
30182-2-4-SM	6	1/4	-4	6.3	1/8x27	35	16	12
30182-2-4B	6	1/4	-4	6.3	1/8x27	35	16	7/16
30182-4-4-SM	6	1/4	-4	6.3	1/4x18	40	21	14
30182-4-4B	6	1/4	-4	6.3	1/4x18	40	21	9/16
30182-6-4	6	1/4	-4	6.3	3/8x18	42	22	11/16
30182-6-4B	6	1/4	-4	6.3	3/8x18	42	22	11/16
30182-4-6-SM	10	3/8	-6	9.5	1/4x18	45	23	14
30182-4-6B	10	3/8	-6	9.5	1/4x18	45	22	9/16
30182-6-6-SM	10	3/8	-6	9.5	3/8x18	45	23	19
30182-8-6-SM	10	3/8	-6	9.5	1/2x14	52	29	22
30182-8-6B-SM	10	3/8	-6	9.5	1/2x14	52	29	22
30182-6-8B	12	1/2	-8	12.7	3/8x18	49	22	11/16
30182-8-8B-SM	12	1/2	-8	12.7	1/2x14	55	29	22
30182-8-10-SM	16	5/8	-10	15.9	1/2x14	66	29	22
30182-8-10B	16	5/8	-10	15.9	1/2x14	66	29	7/8
30182-12-10	16	5/8	-10	15.9	3/4x14	66	29	1-1/16
30182-8-12-SM	20	3/4	-12	19.1	1/2x14	66	29	22
30182-8-12B	20	3/4	-12	19.1	1/2x14	66	29	7/8
30182-12-12	20	3/4	-12	19.1	3/4x14	66	29	1-1/16
30182-12-12B	20	3/4	-12	19.1	3/4x14	66	29	1-1/16

# 02 Female NPTF Pipe – Rigid Straight

SAE J476A / J516

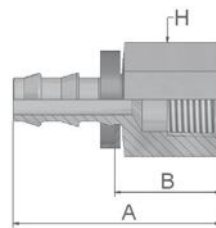

XXXXX-XX-XX Part Number 	Hose I.D.				Thread NPTF	A mm	B mm	H Inch
	DN	Inch	Size	mm				
30282-4-4B	6	1/4	-4	6.3	1/4x18	40	21	3/4
30282-6-6B	10	3/8	-6	9.5	3/8x18	46	23	7/8
30282-8-8B	12	1/2	-8	12.7	1/2x14	55	28	1-1/16

Also available in stainless steel. Details can be found in CAT 4400.1/UK

Approved fitting series for hose types:

B: Brass; K: Without plastic ring; SM: Metric Hexagon

**82**  801 804 821FR 830M 831 836 837BM 837PU 838M

# 03 Male JIC 37° – Rigid Straight

ISO12151-5-S – AGJ

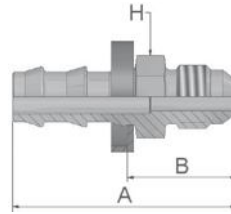

XXXXX-XX-XX Part Number 	Hose I.D.				Thread UNF	A mm	B mm	H Inch
	DN	Inch	Size	mm				
30382-4-4	6	1/4	-4	6.3	7/16x20	40	21	1/2
30382-6-6	10	3/8	-6	9.5	9/16x18	45	22	5/8
30382-6-6B	10	3/8	-6	9.5	9/16x18	45	22	5/8
30382-8-8	12	1/2	-8	12.7	3/4x16	52	26	3/4
30382-8-8B	12	1/2	-8	12.7	3/4x16	52	26	3/4
30382-12-12	20	3/4	-12	19.1	1-1/16x12	69	32	1-1/8
30382-12-12B	20	3/4	-12	19.1	1-1/16x12	69	32	1-1/8

# 06/68 Female – JIC 37° SAE 45° Dual Flare Swivel – Straight

ISO12151-5-SWS – DKJ

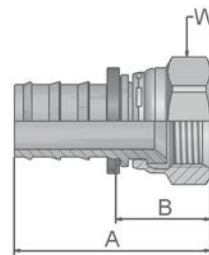

XXXXX-XX-XX Part Number 	Hose I.D.				Thread UNF	A mm	B mm	W mm Inch
	DN	Inch	Size	mm				
30682-4-4-SM	6	1/4	-4	6.3	7/16x20	40	21	14
30682-4-4B	6	1/4	-4	6.3	7/16x20	39	19	9/16
30682-5-4B	6	1/4	-4	6.3	1/2x20	40	21	5/8
30682-6-4B	6	1/4	-4	6.3	9/16x18	42	22	11/16
30682-5-6B	10	3/8	-6	9.5	1/2x20	44	21	5/8
30682-6-6	10	3/8	-6	9.5	9/16x18	46	22	11/16
30682-6-6-SM	10	3/8	-6	9.5	9/16x18	45	22	19
30682-6-6B-SM	10	3/8	-6	9.5	9/16x18	45	22	19
30682-8-6B	10	3/8	-6	9.5	3/4x16	47	24	7/8
36882-8-6-SM	10	3/8	-6	9.5	3/4x16	48	25	22
30682-10-8B	12	1/2	-8	12.7	7/8x14	52	25	1
30682-10-10-SM	16	5/8	-10	15.9	7/8x14	65	28	27
30682-10-10B	16	5/8	-10	15.9	7/8x14	62	25	1
30682-12-12-SM	20	3/4	-12	19.1	1-1/16x12	67	30	32
30682-12-12B-SM	20	3/4	-12	19.1	1-1/16x12	67	31	32

Also available in stainless steel. Details can be found in CAT 4400.1/UK





Approved fitting series for hose types:

B: Brass; K: Without plastic ring; SM: Metric Hexagon

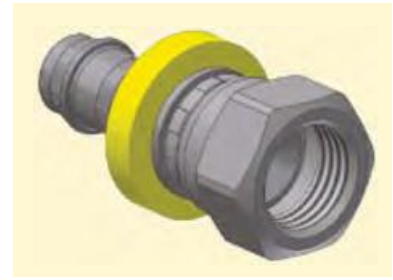
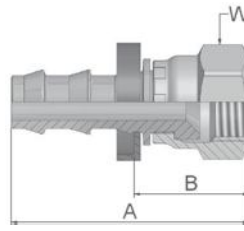
 801 804 821FR 830M 831 836 837BM 837PU 838M

**08**      **Female SAE 45° – Swivel  
Straight**  
SAE J516



XXXXX-XX-XX Part Number 	 Hose I.D.				 Thread UNF	A	B	 W
	DN	Inch	Size	mm		mm	mm	Inch
30882-4-4	6	1/4	-4	6.3	7/16x20	39	19	9/16
30882-4-4B	6	1/4	-4	6.3	7/16x20	39	19	9/16
30882-5-4B	6	1/4	-4	6.3	1/2x20	40	21	5/8
30882-6-6B	10	3/8	-6	9.5	5/8x18	46	23	3/4
30882-8-8	12	1/2	-8	12.7	3/4x16	51	25	7/8
30882-8-8B	12	1/2	-8	12.7	3/4x16	51	25	7/8
30882-10-10	16	5/8	-10	15.9	7/8x14	65	28	1
30882-10-10B	16	5/8	-10	15.9	7/8x14	65	28	1
30882-12-12	20	3/4	-12	19.1	1-1/16x14	67	30	1-1/4
30882-12-12B	20	3/4	-12	19.1	1-1/16x14	67	30	1-1/4

Also available in stainless steel. Details can be found in CAT 4400.1/UK

Approved **fitting series** for hose types:

**B:** Brass; **K:** Without plastic ring; **SM:** Metric Hexagon

**82**  801 804 821FR 830M 831 836 837BM 837PU 838M



### 37/3V Female JIC 37° SAE 45° – Dual Flare Swivel Female 45° Elbow

ISO 12151-5-SWE 45° – DKJ 45°

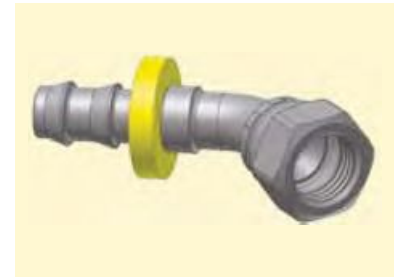
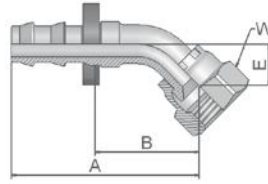

XXXXX-XX-XX Part Number 	Hose I.D.				Thread UNF	A mm	B mm	E mm	W mm Inch
	DN	Inch	Size	mm					
33782-4-4	6	1/4	-4	6.3	7/16x20	39	20	8	9/16
33V82-4-4B-SM	6	1/4	-4	6.3	7/16x20	44	25	10	17
33782-6-6-SM	10	3/8	-6	9.5	9/16x18	51	28	11	19
33782-8-8	12	1/2	-8	12.7	3/4x16	54	35	14	7/8

### 39/3W Female JIC 37° SAE 45° – Dual Flare Swivel Female 90° Elbow

ISO 12151-5-SWES – DKJ 90°

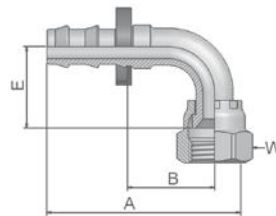

XXXXX-XX-XX Part Number 	Hose I.D.				Thread UNF	A mm	B mm	E mm	W mm Inch
	DN	Inch	Size	mm					
33982-4-4	6	1/4	-4	6.3	7/16x20	39	20	17	5/8
33982-6-6	10	3/8	-6	9.5	9/16x18	50	28	22	11/16
33982-6-6-SM	10	3/8	-6	9.5	9/16x18	47	25	23	19
33982-8-8	12	1/2	-8	12.7	3/4x16	59	33	28	7/8
33W82-8-8-SM	12	1/2	-8	12.7	3/4x16	55	29	28	22
33982-10-10	16	5/8	-10	15.9	7/8x14	74	37	31	1
33982-12-12	20	3/4	-12	19.1	1-1/16x12	84	46	46	1-1/4
33982-12-12-SM	20	3/4	-12	19.1	1-1/16x12	88	52	48	32

Also available in stainless steel. Details can be found in CAT 4400.1/UK

Approved fitting series for hose types:





B: Brass; K: Without plastic ring; SM: Metric Hexagon

 801 804 821FR 830M 831 836 837BM 837PU 838M

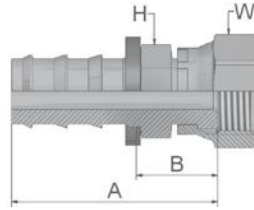
**JC** **Female ORFS  
Swivel – Straight  
Short**

ISO 12151-1 – SWSA  
SAE J516 – ORFS



XXXXX-XX-XX Part Number 	 Hose I.D.				 Thread UNF	A	B	 H	 W
	DN	Inch	Size	mm		mm	mm	mm Inch	mm Inch
3JC82-4-4	6	1/4	-4	6.3	9/16x18	36	17	9/16	11/16
3JC82-6-6	10	3/8	-6	9.5	11/16x16	40	18	11/16	13/16
3JC82-6-6-SM	10	3/8	-6	9.5	11/16x16	40	18	19	22
3JC82-8-6-SM	10	3/8	-6	9.5	13/16x16	43	21	22	24
3JC82-8-8-SM	12	1/2	-8	12.7	13/16x16	47	21	22	24
3JC82-8-10	16	5/8	-10	15.9	13/16x16	57	21	3/4	15/16
3JC82-10-10	16	5/8	-10	15.9	1x14	61	24	15/16	1-1/8
3JC82-10-12	20	3/4	-12	19.1	1x14	61	24	1	1-1/8
3JC82-12-12	20	3/4	-12	19.1	1-3/16x12	67	30	1-1/8	1-3/8

Also available in stainless steel. Details can be found in CAT 4400.1/UK

Approved **fitting series** for hose types:

**B:** Brass; **K:** Without plastic ring; **SM:** Metric Hexagon

**82**  801 804 821FR 830M 831 836 837BM 837PU 838M

## FF Metru-Lok Swivel Female

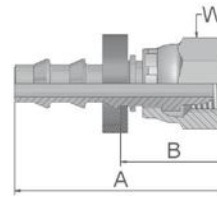

XXXXX-XX-XX Part Number 	Hose I.D.				Thread metric	Tube O.D. mm	A mm	B mm	W mm
	DN	Inch	Size	mm					
3FF82-6-4B	6	1/4	-4	6.3	M10x1	6	36	16	14
3FF82-8-4B	6	1/4	-4	6.3	M12x1	8	31	12	14
3FF82-10-6B	10	3/8	-6	9.5	M14x1	10	35	12	17
3FF82-12-6B	10	3/8	-6	9.5	M16x1	12	35	12	19
3FF82-14-8B	12	1/2	-8	12.7	M18x1	14	38	12	22
3FF82-16-8B	12	1/2	-8	12.7	M22x1.5	16	38	12	27
3FF82-18-10B	16	5/8	-10	15.9	M24x1.5	18	51	15	27
3FF82-22-12B	20	3/4	-12	19.1	M28x1.5	22	51	15	32

## AF Male BSP Parallel Pipe Rigid – Straight (with O-ring Seal)

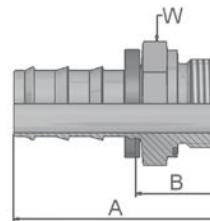

XXXXX-XX-XX Part Number 	Hose I.D.				Thread BSP	A mm	B mm	W mm
	DN	Inch	Size	mm				
3AF82-2-4B	6	1/4	-4	6.3	1/8x28	34	15	17
3AF82-4-4B	6	1/4	-4	6.3	1/4x19	39	20	19
3AF82-4-6B	10	3/8	-6	9.5	1/4x19	43	20	19
3AF82-6-6B	10	3/8	-6	9.5	3/8x19	46	23	22
3AF82-6-8B	12	1/2	-8	12.7	3/8x19	49	22	22
3AF82-8-8B	12	1/2	-8	12.7	1/2x14	53	26	27
3AF82-8-10B	16	5/8	-10	15.9	1/2x14	63	26	27

Also available in stainless steel. Details can be found in CAT 4400.1/UK

Approved fitting series for hose types:



B: Brass; K: Without plastic ring; SM: Metric Hexagon

 801 804 821FR 830M 831 836 837BM 837PU 838M

# NM Male BSP Parallel Pipe L Series – Rigid – Straight ED-Seal

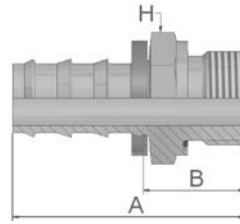
ISO 1179



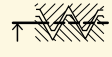

XXXXX-XX-XX Part Number 	 Hose I.D.				 Thread BSP	A	B	H
	DN	Inch	Size	mm		mm	mm	mm
3NM82-6-8B	12	1/2	-8	12.7	3/8x19	52	26	22
3NM82-8-8B	12	1/2	-8	12.7	1/2x14	55	28	27
3NM82-12-12B	20	3/4	-12	19.1	3/4x14	65	28	32

# VW121 BSP Swivel Female

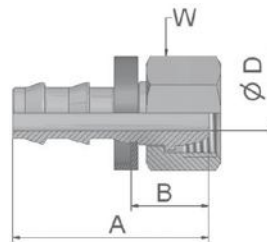
(VW-Norm 39-V-16631)

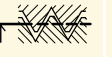

XXXXX-XX-XX Part Number 	 Hose I.D.				 Thread BSP	A	B	D	W
	DN	Inch	Size	mm		mm	mm	mm	mm
VW121-8937*	6	1/4	-4	6.3	1/4x19	32	13	5	17
VW121-8938**	10	3/8	-6	9.5	3/8x19	38	15	7.5	19
VW121-8939**	14	1/2	-8	12.7	1/2x14	46	19	11	27
VW121-8940**	16	5/8	-10	15.9	3/4x14	58	21	14	32
VW121-8941**	20	3/4	-12	19.1	1x11	53	16	17	41

\*stainless steel nipple, steel nut  
\*\*brass nipple, steel nut

Also available in stainless steel. Details can be found in CAT 4400.1/UK



Approved **fitting series** for hose types:

B: Brass; K: Without plastic ring; SM: Metric Hexagon

 801 804 821FR 830M 831 836 837BM 837PU 838M

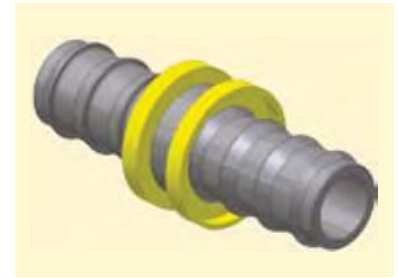
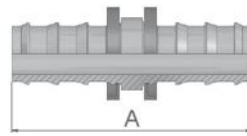



## 82 Push-Lok® Union

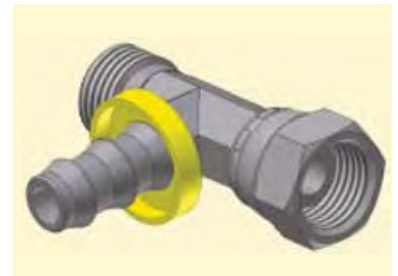
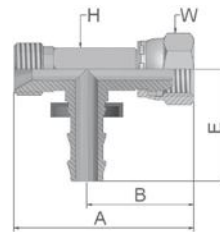

XXXXX-XX-XX Part Number 	 Hose I.D.				A mm
	DN	Inch	Size	mm	
38282-4-4B	6	1/4	-4	6.3	45
38282-4-4	6	1/4	-4	6.3	45
38282-6-6B	10	3/8	-6	9.5	54
38282-8-8	12	1/2	-8	12.7	64
38282-8-8B	12	1/2	-8	12.7	64
38282-10-10	16	5/8	-10	15.9	84
38282-10-10B	16	5/8	-10	15.9	84
38282-12-12	20	3/4	-12	19.1	84
38282-12-12B	20	3/4	-12	19.1	84

## DP Metric Swivel Female Tee Male Stud



XXXXX-XX-XX Part Number 	 Hose I.D.				 Thread metric	A mm	B mm	E mm	 H mm	 W mm
	DN	Inch	Size	mm						
DP-6-6-4BK	6	1/4	-4	6.3	M12x1	43	24	30	11	14
DP-8-8-4BK	6	1/4	-4	6.3	M14x1.5	43	24	30	11	14
DP-10-10-6BK	10	3/8	-6	9.5	M16x1.5	48	26	34	13	19
DP-15-15-8BK	12	1/2	-8	12.7	M22x1.5	58	32	42	17	27

Standard nipples are stocked without plastic collar. If you need a collar, delete K from the part number.

Also available in stainless steel. Details can be found in CAT 4400.1/UK

Approved fitting series for hose types:

B: Brass; K: Without plastic ring; SM: Metric Hexagon

 801 804 821FR 830M 831 836 837BM 837PU 838M

## DR Metric Swivel Female Tee

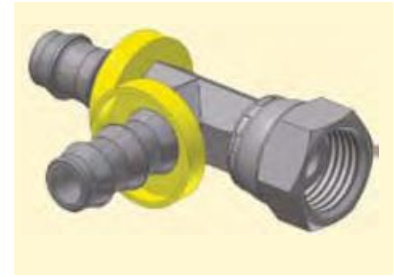
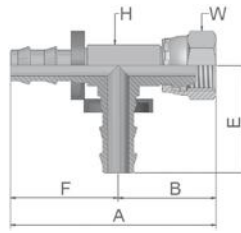

XXXXX-XX-XX Part Number 82	Hose I.D.				Thread metric	A mm	B mm	E mm	F mm	H mm	W mm
	DN	Inch	Size	mm							
DR-6-4-4BK	6	1/4	-4	6.3	M12x1	54	24	30	30	11	14
DR-10-6-6BK	10	3/8	-6	9.5	M16x1.5	59	25	34	34	13	19
DR-15-8-8BK	12	1/2	-8	12.7	M22x1.5	74	32	42	42	17	27

## 5C 60° Cone Swivel Female

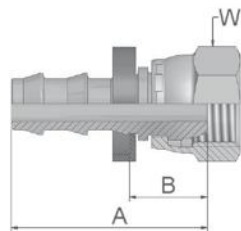

XXXXX-XX-XX Part Number 82	Hose I.D.				Thread metric	A mm	B mm	W mm
	DN	Inch	Size	mm				
35C82-6-4B	6	1/4	-4	6.3	M12x1.5	33	14	14
35C82-6-4BK	6	1/4	-4	6.3	M12x1.5	33	14	14
35C82-10-6BK	10	3/8	-6	9.5	M16x1.5	38	15	19
35C82-10-6B	10	3/8	-6	9.5	M16x1.5	38	15	19
35C82-15-8B	12	1/2	-8	12.7	M22x1.5	44	18	27
35C82-15-8BK	12	1/2	-8	12.7	M22x1.5	44	18	27
35C82-18-10BK	16	5/8	-10	15.9	M26x1.5	56	18	32

Also available in stainless steel. Details can be found in CAT 4400.1/UK

Approved **fitting series** for hose types:

B: Brass; K: Without plastic ring; SM: Metric Hexagon

82 801 804 821FR 830M 831 836 837BM 837PU 838M

## 6C 60° Cone Swivel Female 45° Elbow

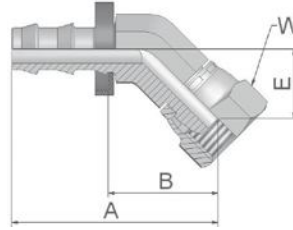

XXXXX-XX-XX Part Number 	Hose I.D.			Thread metric	A mm	B mm	E mm	W mm	
	DN	Inch	Size						mm
36C82-6-4BK	6	1/4	-4	6.3	M12x1.5	44	25	16	14
36C82-10-6BK	10	3/8	-6	9.5	M16x1.5	48	26	16	19
36C82-15-8BK	12	1/2	-8	12.7	M22x1.5	54	28	18	27

## 7C 60° Cone Swivel Female 90° Elbow

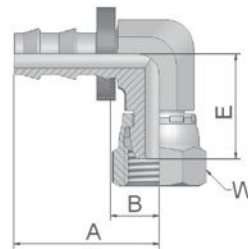

XXXXX-XX-XX Part Number 	Hose I.D.			Thread metric	A mm	B mm	E mm	W mm	
	DN	Inch	Size						mm
37C82-6-4BK	6	1/4	-4	6.3	M12x1.5	30	11	22	14
37C82-10-6BK	10	3/8	-6	9.5	M16x1.5	34	11	25	19
37C82-15-8BK	12	1/2	-8	12.7	M22x1.5	43	16	32	27

Also available in stainless steel. Details can be found in CAT 4400.1/UK

Approved **fitting series** for hose types:

**B:** Brass; **K:** Without plastic ring; **SM:** Metric Hexagon

**82**  801 804 821FR 830M 831 836 837BM 837PU 838M



## Assembly Instructions

1. Cut the hose right angled with a sharp knife. If necessary it is possible to use a lubricant (water/soap solution with 5 % soap fluid and 95 % water) for easy assembly.
2. Insert fitting into hose until first barb is in hose. Place end of fitting against a flat object (bench, door, wall) and grip hose approximately 1" from end and push with a steady force until end of hose is covered by yellow plastic collar. Alternatively please use the Parker Assembly Tool No. 611050G or 611050HV.

### Attention!

During assembly, please keep in mind that Push-Lok fittings will provide an effective grip only when the Push-Lok hose is pushed fully on the insert, where the cropped end of the hose should be fully concealed by the plastic collar. For easy assembly of hose 830M, 837BM and 837PU please use only Push-Lok Assembly Oil No. H896137. Push-Lok Assembly Oil is free from wetting disturbing substances.

Don't use oil, lubricant or soap fluids for this hose!



## Disassembly Instructions

1. Cut lengthwise along a line at approximately a 20 angle from centre line of hose. The cut should be approximately 1" long. Be careful not to nick barbs when cutting the hose.
2. Grip hose and give a sharp down-ward tug to disengage from fitting.

### Attention!

Before re-use of the nipple please check nipple for damage. Damaged nipples can cause leakage.

## Assembly Tool

Tool designed for assembly of Push-Lok fittings and hose in all sizes. Toggle actions greatly reduce effort necessary to hold hose and press in fitting. Only a few pounds of force is needed on either handle to quickly assemble any size.

Light version  
Part No. 611050G



Heavy version  
Part No. 611050HV

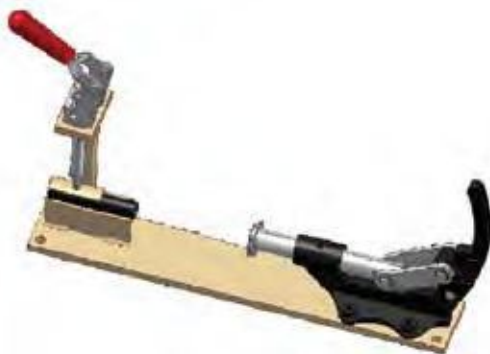

Push-Lok Assembly Oil  
1-litre bottle Part No. H896137







# Low-Pressure Transportation and Hydraulic Hose and Fittings

– the right solution for special applications and requirements



- A wide range of different hose types in rubber is available, with textile-braided or fire-retardant covers
- Proven, safe and easy self-assembly system
- Large bore sizes available
- High working temperatures
- One fitting series for all SAE 100 R5 and similar hoses



# Parkrimp® *No-Skive*

The system for fast and leak-free assemblies

- No skiving tool needed
- No need to remove the cover
- Crimps one-piece fittings
- Parkalign positions the fittings in the dies perfectly every time
- Quick and easy: no gauges to set on the machine
- Portable machines for field repair
- Meets EN safety regulations

## The perfect match



The complete system from one source. No-Skive hose, No-Skive fitting and crimping machine with world-wide guarantee and availability.

## Parker's colour-coded die sets



No loose parts to mismatch or misplace – die set segments linked together. Die sets provide 360° evenly applied crimping forces for an ideal crimp result.

## Parkalign®



Parker's exclusive Parkalign® positions the fitting in the dies perfectly every time.



## Applications

The definitive hose range for all special applications and requirements





# Transportation and Hydraulic Hoses and Fittings

Low pressure	Transportation + Hydraulic	No-Skive Hose	201	<i>No-Skive</i>	B2a-1
			206	<i>No-Skive</i>	B2a-2
			213	<i>No-Skive</i>	B2a-3
			221FR	<i>No-Skive</i>	B2a-4
			285	<i>No-Skive</i>	B2a-5
			293	<i>No-Skive</i>	B2a-6
			601	<i>No-Skive</i>	B2a-7
			611	<i>No-Skive</i>	B2a-8
			611HT	<i>No-Skive</i>	B2a-9
			681	<i>No-Skive</i>	B2a-10
			681DB	<i>No-Skive</i>	B2a-11
	Fittings 26 series	DIN - Metric	B2b-1 – B2b-2		
		BSP	B2b-3 – B2b-4		
		SAE	B2b-5 – B2b-7		
		ORFS	B2b-8		
		Others	B2b-9 – B2b-11		

## Standard

<p><b>601</b> B2a-7</p>  <p><i>No-Skive</i> SAE 100R3</p>	<p><b>611</b> B2a-8</p>  <p><i>No-Skive</i> DIN EN 854-R6</p>	<p><b>681</b> B2a-10</p>  <p><i>No-Skive 2TE</i> DIN EN 854-2TE</p>
--	--	---

## High temperature

<p><b>611HT</b> B2a-9</p>  <p><i>No-Skive</i> High-temperature textile hose</p>
--

## Railway

<p><b>681DB</b> B2a-11</p>  <p><i>No-Skive 2TE</i> DIN EN 854-2TE (with approvals for rail transportation)</p>
---

## Transportation

<p><b>201</b> B2a-1</p>  <p><i>No-Skive Airbrake</i> SAE 100R5 – SAE J1402AII</p>	<p><b>206</b> B2a-2</p>  <p><i>No-Skive Airbrake</i> SAE 100R5 – SAE J1402AII</p>	<p><b>213</b> B2a-3</p>  <p><i>No-Skive High Temperature</i> For engines and compressed air systems</p>	<p><b>293</b> B2a-6</p>  <p><i>No-Skive High Temperature</i> Engine and air brake/truck hose</p>
--	--	---	---

## Fire retardant

<p><b>221FR</b> B2a-4</p>  <p><i>No-Skive Fire Retardant</i> Marine fuel and engine hose</p>
---

## Refrigeration

<p><b>285</b> B2a-5</p>  <p><b>Air Conditioning and Refrigeration</b> SAE J2064 Type C, Class 1</p>
--

# 201

## No-Skive Airbrake

SAE 100R5 – SAE J1402AII

### Primary Applications

Transportation: Air brake hose

General: Low pressure applications

### Type Approvals

Details please find on pages **Ab-14** and **Ab-15**

### Applicable Specifications

SAE 100R5, SAE J1402AII, D. O. T. FMVSS 106-AII

### Construction

Tube: Synthetic rubber

Reinforcement: Textile inner braid,  
high tensile steel wire braid

Cover: Rubber layer and textile braided cover

Temperature Range ..... -40 °C up to +150 °C

Exception: Air ..... max. +70 °C

Water ..... max. +85 °C



- Textile braided cover
- *No-Skive* hose construction
- 150 °C working temperature

### Recommended Fluids

Petroleum based hydraulic fluids, water-glycol and water-oil emulsion hydraulic fluids, grease, lubricants, crude and fuel oils, air and water.

Consult the chemical compatibility section on pages **Ab-22** to **Ab-30** for more detailed information.

### Fitting Series



Part Number	Hose I.D.				Hose O.D. mm	Pressure Rating				Vacuum kilo Pascal *1 kPa	min. bend radius mm	weight kg
	DN	Inch	Size	mm		max. dynamic working pressure		min. burst pressure				
						MPa	psi	MPa	psi			
201-4		3/16	-4	5.0	12.2	20.7	3000	83	12000	95	75	0.22
201-5		1/4	-5	6.3	14.8	20.7	3000	83	12000	95	85	0.27
201-6		5/16	-6	8.0	17.2	15.5	2250	62	9000	95	100	0.34
201-8		13/32	-8	10.0	19.5	13.8	2000	55	8000	95	120	0.40
201-10		1/2	-10	12.5	23.4	12.0	1750	48	7000	95	140	0.55
201-12		5/8	-12	16.0	27.4	10.3	1500	41	6000	95	165	0.68
201-16		7/8	-16	22.0	31.4	5.5	800	22	3200	67	185	0.68
201-20		1-1/8	-20	29.0	38.1	4.3	625	17	2500	67	230	0.76
201-24		1-3/8	-24	35.0	44.5	3.5	500	14	2000	51	265	1.01
201-32		1-13/16	-32	46.0	56.4	2.4	350	10	1400	37	335	1.32

\*1 = the vacuum values listed in the table are vacuum pressure values in kPa. For an absolute value subtract the table value from 101kPa.

The combination of high temperature and high pressure could reduce the hose life.

The maximum working pressures shown in the table are for service up to a maximum temperature of 100 °C.

For use at higher temperatures, consult the pressure/temperature curve in section A for the reduced maximum working pressure.

# 206

## No-Skive Airbrake

SAE 100R5 – SAE J1402AII

### Primary Applications

Transportation: Air brake hose

General: Low pressure applications

### Type Approvals

Details please find on pages **Ab-14** and **Ab-15**

### Applicable Specifications

SAE 100R5, SAE J1402AII, D. O. T. FMVSS 106-AII

### Construction

Tube: Parker PKR-elastomer tube

Reinforcement: Textile inner braid,  
high tensile steel wire braid

Cover: Rubber layer and  
blue textile braided cover

Temperature Range ..... -48 °C up to +150 °C

Exception: Air ..... max. +100 °C

Water ..... max. +85 °C



- Blue textile braided cover
- *No-Skive* hose construction
- For very low (-48 °C) working temperature

### Recommended Fluids

Petroleum based hydraulic fluids, water-glycol and water-oil emulsion hydraulic fluids, grease, lubricants, crude and fuel oils, air and water.

Consult the chemical compatibility section on pages **Ab-22** to **Ab-30** for more detailed information.

### Fitting Series



Part Number	Hose I.D.				Hose O.D. mm	Pressure Rating				Vacuum kilo Pascal *1 kPa	min. bend radius mm	weight kg
	DN	Inch	Size	mm		max. dynamic working pressure		min. burst pressure				
						MPa	psi	MPa	psi			
206-4		3/16	-4	5.0	13.2	20.7	3000	83	12000	95	75	0.22
206-5		1/4	-5	6.3	14.8	20.7	3000	83	12000	95	85	0.27
206-6		5/16	-6	8.0	17.1	15.5	2250	62	9000	95	90	0.34
206-8		13/32	-8	10.0	19.5	13.8	2000	55	8000	95	90	0.40
206-10		1/2	-10	12.5	23.4	12.0	1750	48	7000	95	100	0.55
206-12		5/8	-12	16.0	27.4	10.3	1500	41	6000	95	100	0.68
206-16		7/8	-16	22.0	31.4	5.5	800	22	3200	67	100	0.68
206-20		1-1/8	-20	29.0	38.1	4.3	625	17	2500	67	140	0.76
206-24		1-3/8	-24	35.0	44.5	3.5	500	14	2000	51	190	1.01
206-32		1-13/16	-32	46.0	56.4	2.4	350	10	1400	37	335	1.32

\*1 = the vacuum values listed in the table are vacuum pressure values in kPa. For an absolute value subtract the table value from 101kPa.

The combination of high temperature and high pressure could reduce the hose life.

The maximum working pressures shown in the table are for service up to a maximum temperature of 100 °C.

For use at higher temperatures, consult the pressure/temperature curve in section A for the reduced maximum working pressure.



# 213

## No-Skive High Temperature

For engines and compressed air systems



- *No-Skive* hose construction
- Ideal for high-temperature and small bend radii applications
- Compatible with a large range of fluids

### Primary Applications

Transportation: Air brake hose

Compressors: Compressed air hose

### Type Approvals

Details please find on pages **Ab-14** and **Ab-15**

### Applicable Specifications

SAE J1402AI, D.O.T. FMVSS 106-AI

### Construction

Tube: Parker PKR-elastomer tube

Reinforcement: Textile inner braid,  
high tensile steel wire braid

Cover: Rubber layer and  
black textile braided cover  
include 2 green strips

### Recommended Fluids

Petroleum based hydraulic fluids, water-glycol and water-oil emulsion hydraulic fluids, grease, lubricants, crude and fuel oils, air and water.

Consult the chemical compatibility section on pages **Ab-22** to **Ab-30** for more detailed information.

Temperature Range ..... -45 °C up to +150 °C

Exception: Air ..... max. +100 °C

Water ..... max. +85 °C

### Fitting Series



Part Number	Hose I.D.				Hose O.D. mm	Pressure Rating				min. bend radius mm	weight kg
	DN	Inch	Size	mm		max. dynamic working pressure		min. burst pressure			
						MPa	psi	MPa	psi		
213-4		3/16	-4	5.0	12.5	13.8	2000	55.0	8000	20	0.18
213-5		1/4	-5	6.3	14.1	10.3	1500	41.0	6000	25	0.21
213-6		5/16	-6	8.0	15.7	10.3	1500	41.0	6000	30	0.25
213-8		13/32	-8	10.0	18.7	8.6	1250	34.0	5000	45	0.30
213-10		1/2	-10	12.5	21.1	6.9	1000	28.0	4000	55	0.33
213-12		5/8	-12	16.0	24.3	5.2	750	21.0	3000	70	0.36
213-16		7/8	-16	22.0	30.6	2.8	400	11.0	1600	90	0.45
213-20		1-1/8	-20	29.0	37.8	2.1	300	8.0	1200	115	0.65
213-24		1-3/8	-24	35.0	44.0	1.7	300	8.0	1200	190	0.73
213-32		1-13/16	-32	46.0	54.5	1.4	200	5.5	800	355	1.00

The combination of high temperature and high pressure could reduce the hose life.

The maximum working pressures shown in the table are for service up to a maximum temperature of 100 °C.

For use at higher temperatures, consult the pressure/temperature curve in section A for the reduced maximum working pressure.

# 221FR

## No-Skive Fire Retardant

Marine fuel and engine hose

### Primary Applications

Marine: Marine fuel hose  
General: Where fire retardance is an issue

### Type Approvals

Details please find on pages **Ab-14** and **Ab-15**

### Applicable Specifications

SAE J1527 R3, USCG Type AI, SAE J1942, ISO 7840

### Construction

Tube: Fuel and oil-resistant rubber  
Reinforcement: High tensile steel wire braid  
Cover: Flame retardant special fibre outer cover

Temperature Range ..... -20 °C up to +100 °C

Exception: Air ..... max. +70 °C  
Water ..... max. +85 °C



- Fire retardant hose cover
- *No-Skive* hose construction
- Marine approvals

### Recommended Fluids

Petroleum based hydraulic fluids, water-glycol and water-oil emulsion hydraulic fluids, grease, lubricants, crude, fuel oils and water.

Consult the chemical compatibility section on pages **Ab-22** to **Ab-30** for more detailed information.

### Fitting Series



Part Number	Hose I.D.				Hose O.D. mm	Pressure Rating				Vacuum kilo Pascal *1 kPa	min. bend radius mm	weight kg
	DN	Inch	Size	mm		max. dynamic working pressure		min. burst pressure				
						MPa	psi	MPa	psi			
221FR-5		1/4	-5	6.3	15	3.5	500	14.0	2000	81	25	0.28
221FR-6		5/16	-6	8.0	17	3.5	500	14.0	2000	81	30	0.34
221FR-8		13/32	-8	10.0	20	3.5	500	14.0	2000	81	45	0.42
221FR-10		1/2	-10	12.5	23	3.5	500	14.0	2000	68	55	0.58
221FR-12		5/8	-12	16.0	27	3.5	500	14.0	2000	68	70	0.61
221FR-16		7/8	-16	22.0	31	3.5	500	14.0	2000	68	90	0.70

\*1 = the vacuum values listed in the table are vacuum pressure values in kPa. For an absolute value subtract the table value from 101kPa. The combination of high temperature and high pressure could reduce the hose life.

# 285

## Air Conditioning and Refrigeration

SAE J2064 Type C, Class 1



- *No-Skive* hose construction
- Usable for main refrigerant fluids
- Compatible with modern refrigerants

### Primary Applications

Air Conditioning: For industrial and mobile applications

### Applicable Specifications

SAE J2064 Type C, Class 1

### Construction

Tube: Nylon barrier between two elastomeric layers  
 Reinforcement: One textile braid  
 Cover: Heat, moisture and ozone resistant rubber

### Recommended Fluids

For use with Freon refrigerants 12, 134a and 22. Consult the chemical compatibility section on pages **Ab-22** to **Ab-30** for more detailed information.

Temperature Range ..... -30 °C up to +125 °C

### Fitting Series



Part Number	Hose I.D.				Hose O.D. mm	Pressure Rating				Vacuum kilo Pascal *1 kPa	min. bend radius mm	weight kg
	DN	Inch	Size	mm		max. dynamic working pressure		min. burst pressure				
						MPa	psi	MPa	psi			
285-4-RL		3/16	-4	5,0	12,4	3,4	500	17,2	2500	95	25	0,14
285-6-RL		5/16	-6	8,0	15,7	3,4	500	17,2	2500	95	38	0,19
285-8-RL		13/32	-8	10,0	18,8	3,4	500	17,2	2500	95	51	0,25
285-10-RL		1/2	-10	12,5	21,1	3,4	500	17,2	2500	95	64	0,27
285-12-RL		5/8	-12	16,0	24,4	3,4	500	17,2	2500	95	76	0,34

\*1 = the vacuum values listed in the table are vacuum pressure values in kPa. For an absolute value subtract the table value from 101kPa.  
 For size -16 a hose 285-16 is available on request.  
 RL = only available on reels.

# 293

## No-Skive High Temperature

Engine and air brake/truck hose

### Primary Applications

Truck Market: Air brake hose  
Engine cooling circuit

### Type Approvals

Details please find on pages **Ab-14** and **Ab-15**

### Applicable Specifications

SAE J1402AI, D.O.T. FMVSS 106

### Construction

Tube: Synthetic PKR rubber  
Reinforcement: One textile braid  
Cover: Black nylon braid

Temperature Range ..... -50 °C up to +150 °C

Exception: Air ..... max. +100 °C

Water ..... max. +85 °C



- High temperature  
– high flex hose performance
- *No-Skive* hose construction
- Wide temperature range

### Recommended Fluids

Petroleum-based hydraulic fluids and lubrication oils, diesel fuels and antifreeze solutions; water-, water-oil- and water-glycol emulsion hydraulic fluids.

Consult the chemical compatibility section on pages **Ab-22** to **Ab-30** for more detailed information.

### Fitting Series



Part Number	Hose I.D.				Hose O.D. mm	Pressure Rating				min. bend radius mm	weight kg
	DN	Inch	Size	mm		max. dynamic working pressure		min. burst pressure			
						MPa	psi	MPa	psi		
293-4-RL		3/16	-4	5.0	12.5	3.5	500	13.8	2000	15	0.15
293-6-RL		5/16	-6	8.0	15.7	3.5	500	13.8	2000	25	0.22
293-8-RL		13/16	-8	10.0	18.7	3.5	500	13.8	2000	40	0.27
293-10-RL		1/2	-10	12.5	21.1	3.1	450	12.4	1800	50	0.30
293-12-RL		5/8	-12	16.0	24.3	3.1	450	12.4	1800	65	0.33
293-16-RL		7/8	-16	22.0	30.6	3.1	450	12.4	1800	80	0.37

The combination of high temperature and high pressure could reduce the hose life.  
RL = only available on reels.

# 601

*No-Skive*

SAE 100R3



- Textile braided reinforcement
- *No-Skive* hose construction
- Small bend radii
- Up to +125 °C working temperature

## Primary Applications

General Market: Low pressure hydraulic applications

## Applicable Specifications

SAE 100R3, DIN EN 854-R3

## Construction

Tube: Synthetic rubber  
 Reinforcement: Two layers of textile braid  
 Cover: MSHA accepted synthetic rubber

Temperature Range ..... -40 °C up to +125 °C

Exception: Air ..... max. +70 °C  
 Water ..... max. +85 °C

## Recommended Fluids

Petroleum based hydraulic fluids, water-glycol and water-oil emulsion hydraulic fluids, grease, lubricants, crude and fuel oils, air and water.

Consult the chemical compatibility section on pages **Ab-22** to **Ab-30** for more detailed information.

## Fitting Series

- Available as complete hose assembly
- Parker 43 series fittings are compatible with this hose and are available only upon request.

Part Number	Hose I.D.				Hose O.D. mm	Pressure Rating				min. bend radius mm	weight kg
	DN	Inch	Size	mm		max. dynamic working pressure		min. burst pressure			
						MPa	psi	MPa	psi		
601-4	6	1/4	-4	6,3	14,0	8,6	1250	35,0	5000	75	0,19
601-6	10	3/8	-6	9,5	19,0	7,8	1125	31,0	4500	100	0,33
601-8	12	1/2	-8	12,7	23,0	6,9	1000	28,0	4000	130	0,42
601-12	20	3/4	-12	19,1	32,0	5,2	750	21,0	3000	150	0,64
601-16	25	1	-16	25,4	38,0	3,9	565	16,0	2250	200	0,91

The combination of high temperature and high pressure could reduce the hose life.

# 611

*No-Skive*

DIN EN 854-R6



- Two layers of textile braid
- According to DIN EN 854-R6
- *No-Skive* hose construction for 2-piece fittings

## Primary Applications

General Market: Low pressure hydraulic applications

## Applicable Specifications

DIN EN 854-R6

## Construction

Tube: Synthetic rubber  
Reinforcement: Two layers of textile braid  
Cover: Synthetic rubber

Temperature Range ..... -40 °C up to +100 °C

Exception: Air ..... max. +70 °C

Water ..... max. +85 °C

## Recommended Fluids

Petroleum based hydraulic fluids, water-glycol and water-oil emulsion hydraulic fluids, grease, lubricants, crude and fuel oils, air and water.

Consult the chemical compatibility section on pages **Ab-22** to **Ab-30** for more detailed information.

## Fitting Series

- Available as complete hose assembly
- Compatible with 2-piece fittings for use with adjustable crimpers only (47 series nipple and 10064 series shell)

Part Number	Hose I.D.				Hose O.D. mm	Pressure Rating				min. bend radius mm	weight kg
	DN	Inch	Size	mm		max. dynamic working pressure		min. burst pressure			
						MPa	psi	MPa	psi		
611-4	6	1/4	-4	6.3	12.8	2.8	400	11.2	1600	65	0.13
611-6	10	3/8	-6	9.5	16.0	2.8	400	11.2	1600	75	0.16
611-8	12	1/2	-8	12.7	20.0	2.8	400	11.2	1600	100	0.27
611-10	16	5/8	-10	15.9	23.2	2.4	350	9.6	1400	125	0.28
611-12	20	3/4	-12	19.0	26.2	2.1	300	8.4	1200	150	0.36

The combination of high temperature and high pressure could reduce the hose life.

# 611HT

*No-Skive*

High-temperature textile hose

## Primary Applications

General Market: Low pressure hydraulic applications/  
high temperature applications

Engine Applications:

Diesel fuel lines, engine cooling circuits

## Type Approvals

Details please find on pages **Ab-14** and **Ab-15**

## Applicable Specifications

DIN EN 854-R6

## Construction

Tube: Synthetic PKR rubber

Reinforcement: One textile braid

Cover: MSHA accepted synthetic rubber

Temperature Range ..... -40 °C up to +150 °C

Exception: Air ..... max. +100 °C

Water ..... max. +85 °C



- For high demand applications, such as diesel fuel lines, water cooling or high-temp lines up to +150 °C
- MSHA - accepted synthetic rubber cover
- According to DIN EN 854-R6
- *No-Skive* hose construction for 2-piece fittings

## Recommended Fluids

Petroleum-based hydraulic fluids and lubrication oils, diesel fuels and antifreeze solutions; water-glycol and water-oil emulsion, air and water.

Consult the chemical compatibility section on pages **Ab-22** to **Ab-30** for more detailed information.

## Fitting Series

- Available as complete hose assembly
- Compatible with 2-piece fittings for use with adjustable crimpers only (47 series nipple and 10064 series shell)

Part Number	Hose I.D.				Hose O.D. mm	Pressure Rating				min. bend radius mm	weight kg
	DN	Inch	Size	mm		max. dynamic working pressure		min. burst pressure			
						MPa	psi	MPa	psi		
611HT-4	6	1/4	-4	6.3	12.8	2.8	400	11.2	1600	65	0.13
611HT-6	10	3/8	-6	9.5	16.0	2.8	400	11.2	1600	75	0.16
611HT-8	12	1/2	-8	12.7	20.0	2.8	400	11.2	1600	100	0.27
611HT-10	16	5/8	-10	15.9	23.2	2.4	350	9.6	1400	125	0.28
611HT-12	20	3/4	-12	19.0	26.2	2.1	300	8.4	1200	150	0.36

The combination of high temperature and high pressure could reduce the hose life.

# 681

## No-Skive 2TE

DIN EN 854-2TE



- Two layers of fabric braid
- *No-Skive* hose construction
- Small bend radii

### Primary Applications

General Market: Low pressure hydraulic application

### Applicable Specifications

DIN EN 854-2TE

### Construction

Tube: Synthetic rubber  
Reinforcement: Two layers of textile braid  
Cover: Synthetic rubber

Temperature Range ..... -40 °C up to +100 °C

Exception: Air ..... max. +70 °C

Water ..... max. +85 °C

### Recommended Fluids

Petroleum based hydraulic fluids, water-glycol and water-oil emulsion hydraulic fluids, grease, lubricants, crude and fuel oils, air and water.

Consult the chemical compatibility section on pages **Ab-22** to **Ab-30** for more detailed information.

### Fitting Series

- Available as complete hose assembly
- Compatible with 2-piece fittings for use with adjustable crimpers only (47 series nipple and 10064 series shell)

Part Number	Hose I.D.				Hose O.D. mm	Pressure Rating				min. bend radius mm	weight kg
	DN	Inch	Size	mm		max. dynamic working pressure		min. burst pressure			
						MPa	psi	MPa	psi		
681-4	6	1/4	-4	6.3	13.1	7.5	1090	30.0	4360	40	0.15
681-5	8	5/16	-5	7.9	14.6	6.8	980	27.0	3920	50	0.16
681-6	10	3/8	-6	9.5	16.2	6.3	910	25.0	3640	60	0.19
681-8	12	1/2	-8	12.7	19.9	5.8	840	23.0	3360	70	0.24
681-10	16	5/8	-10	15.9	23.4	5.0	725	20.0	2900	90	0.35
681-12	20	3/4	-12	19.1	26.5	4.5	650	18.0	2600	110	0.39
681-16	25	1	-16	25.4	33.4	4.0	580	16.0	2320	150	0.59

The combination of high temperature and high pressure could reduce the hose life.



# 681DB

## No-Skive 2TE

DIN EN 854-2TE

(with approvals for rail transportation)

### Primary Applications

General Market: Low pressure hydraulic application

Rail Transportation Market:

Hydraulic applications around  
train vehicles

### Type Approvals

Details please find on pages **Ab-14** and **Ab-15**

### Applicable Specifications

DIN EN 854-2TE

### Construction

Tube: Synthetic rubber

Reinforcement: Two layers of textile braid

Cover: Flame retardant synthetic rubber

Temperature Range ..... -40 °C up to +100 °C

Exception: Air ..... max. +70 °C

Water ..... max. +85 °C



- Two layers of fabric braid
- **No-Skive** hose construction
- Small bend radii
- Flame retardant rubber cover
- Railway approved as follows:
  - German Standard: **DIN 5510-2**
  - French Standard: **NF F16-101/102 I2/F3**
  - British Standard: **BS 6853 - Table 4**

### Recommended Fluids

Petroleum based hydraulic fluids, water-glycol and water-oil emulsion hydraulic fluids, grease, lubricants, crude and fuel oils, air and water.

Consult the chemical compatibility section on pages **Ab-22** to **Ab-30** for more detailed information.





### Fitting Series

- Available as complete hose assembly
- Compatible with 2-piece fittings for use with adjustable crimpers only (47 series nipple and 10064 series shell)





Part Number	Hose I.D.				Hose O.D. mm	Pressure Rating				min. bend radius mm	weight kg
	DN	Inch	Size	mm		max. dynamic working pressure		min. burst pressure			
						MPa	psi	MPa	psi		
681DB-4	6	1/4	-4	6.3	13.1	7.5	1090	30.0	4360	40	0.15
681DB-5	8	5/16	-5	7.9	14.6	6.8	980	27.0	3920	50	0.16
681DB-6	10	3/8	-6	9.5	16.2	6.3	910	25.0	3640	60	0.19
681DB-8	12	1/2	-8	12.7	19.9	5.8	840	23.0	3360	70	0.24
681DB-10	16	5/8	-10	15.9	23.4	5.0	725	20.0	2900	90	0.35
681DB-12	20	3/4	-12	19.1	26.5	4.5	650	18.0	2600	110	0.39
681DB-16	25	1	-16	25.4	33.4	4.0	580	16.0	2320	150	0.59

The combination of high temperature and high pressure could reduce the hose life.





## DIN – Metric

Page B2b-1 – B2b-2			
<p><b>CA</b> B2b-1</p>  <p>Female Metric 24° Light Series with O-Ring Swivel – Straight ISO 12151-2-SWS-L – DKOL</p>	<p><b>CE</b> B2b-1</p>  <p>Female Metric 24° Light Series with O-Ring Swivel – 45° Elbow ISO 12151-2-SWE 45°-L – DKOL 45°</p>	<p><b>CF</b> B2b-2</p>  <p>Female Metric 24° Light Series with O-Ring Swivel – 90° Elbow ISO 12151-2-SWE-L – DKOL 90°</p>	<p><b>49</b> B2b-2</p>  <p>Metric Banjo Straight DIN 7642</p>

## BSP

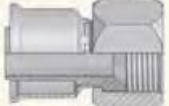
Page B2b-3 – B2b-4			
<p><b>92</b> B2b-3</p>  <p>Female BSP Parallel Pipe Swivel – Straight (60° Cone) BS5200-A – DKR</p>	<p><b>B1</b> B2b-3</p>  <p>Female BSP Parallel Pipe Swivel 45° Elbow (60° Cone) BS 5200-D – DKR 45°</p>	<p><b>B2</b> B2b-4</p>  <p>Female BSP Parallel Pipe Swivel 90° Elbow (60° Cone) BS 5200-B – DKR 90°</p>	<p><b>91</b> B2b-4</p>  <p>Male BSP Taper Pipe – Rigid Straight BS5200 – AGR-K</p>





## SAE

Page B2b-5 – B2b-7			
<p><b>01</b> B2b-5</p>  <p>Male NPTF Pipe Rigid – Straight SAE J476A / J516 – AGN</p>	<p><b>06/68</b> B2b-5</p>  <p>Female – JIC 37° SAE 45° Dual Flare Swivel – Straight ISO12151-5-SWS – DKJ</p>	<p><b>08</b> B2b-6</p>  <p>Female SAE 45° – Swivel Straight SAE J516</p>	<p><b>37/3V</b> B2b-6</p>  <p>Female JIC 37° SAE 45° – Dual Flare Swivel Female 45° Elbow ISO 12151-5-SWE 45° – DKJ 45°</p>
<p><b>39/3W</b> B2b-7</p>  <p>Female JIC 37° SAE 45° – Dual Flare Swivel Female 90° Elbow ISO 12151-5-SWES – DKJ 90°</p>			

# ORFS

<b>Page B2b-8</b>	
<p><b>JC</b>  <b>B2b-8</b>                  Female ORFS                  Swivel – Straight                  Short                  ISO 12151-1 – SWSA                  SAE J516 – ORFS</p>	

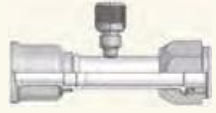
# Others

<b>Page B2b-9 – B2b-11</b>			
<p><b>5S</b>  <b>B2b-9</b></p>  <p>Female Tube O-ring Swivel                  Short Pilot</p>	<p><b>5H</b>  <b>B2b-9</b></p>  <p>Female Tube O-Ring Swivel                  45° Elbow – Short Pilot</p>	<p><b>5T</b>  <b>B2b-10</b></p>  <p>Female Tube O-Ring Swivel                  90° Elbow – Short Pilot</p>	<p><b>59PT</b>  <b>B2b-10</b></p>  <p>Male Tube O-Ring Swivel                  Long Pilot                  With Charge Port at 180° for R134a</p>
<p><b>5LPT</b>  <b>B2b-11</b></p>  <p>Female Tube O-Ring Swivel                  90° Elbow – Long Pilot                  With Charge Port at 180° for R134a</p>			



**CA** **Female Metric 24°  
Light Series with O-Ring  
Swivel – Straight**

ISO 12151-2-SWS-L – DKOL

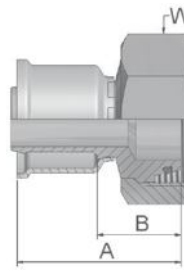

XXXXX-XX-XX Part Number 26	Hose I.D.			Thread metric	Tube O.D. mm	A mm	B mm	W mm
	Inch	Size	mm					
1CA26-6-4	3/16	-4	5.0	M12x1.5	6	40	20	14
1CA26-8-4	3/16	-4	5.0	M14x1.5	8	41	21	17
1CA26-10-5	1/4	-5	6.3	M16x1.5	10	41	20	19
1CA26-10-6	5/16	-6	8.0	M16x1.5	10	41	20	19
1CA26-12-6	5/16	-6	8.0	M18x1.5	12	41	21	22
1CA26-12-8	13/32	-8	10.0	M18x1.5	12	41	21	22
1CA26-15-8	13/32	-8	10.0	M22x1.5	15	42	21	27
1CA26-18-10	1/2	-10	12.5	M26x1.5	18	46	23	32
1CA26-18-12	5/8	-12	16.0	M26x1.5	18	46	23	32
1CA26-22-12	5/8	-12	16.0	M30x2	22	48	25	36
1CA26-28-16	7/8	-16	22.0	M36x2	28	54	28	41
1CA26-28-20	1-1/8	-20	29.0	M36x2	28	60	34	41
1CA26-35-20	1-1/8	-20	29.0	M45x2	35	56	29	50
1CA26-35-24	1-3/8	-24	35.0	M45x2	35	62	34	50
1CA26-42-24	1-3/8	-24	35.0	M52x2	42	59	31	60

Hose fittings are delivered with ozone resistant Nitrile (NBR) O-ring as a standard version. Working temperature from -30 °C up to +105 °C.  
Hose fittings with special O-rings (Viton or EPDM) available on request. For O-ring dimensions and part-numbers see Section Eb.

**CE** **Female Metric 24°  
Light Series with O-Ring  
Swivel – 45° Elbow**

ISO 12151-2-SWE 45°-L – DKOL 45°

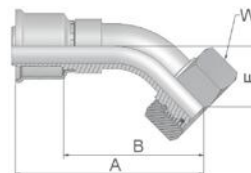

XXXXX-XX-XX Part Number 26	Hose I.D.			Thread metric	Tube O.D. mm	A mm	B mm	E mm	W mm
	Inch	Size	mm						
1CE26-10-6	5/16	-6	8.0	M16x1.5	10	66	45	17	19
1CE26-12-6	5/16	-6	8.0	M18x1.5	12	66	45	17	22
1CE26-12-8	13/32	-8	10.0	M18x1.5	12	59	39	17	22
1CE26-15-8	13/32	-8	10.0	M22x1.5	15	60	39	17	27
1CE26-18-10	1/2	-10	12.5	M26x1.5	18	69	46	21	32
1CE26-18-12	5/8	-12	16.0	M26x1.5	18	73	50	22	32
1CE26-22-12	5/8	-12	16.0	M30x2	22	77	55	26	36
1CE26-28-16	7/8	-16	22.0	M36x2	28	103	76	33	41

Hose fittings are delivered with ozone resistant Nitrile (NBR) O-ring as a standard version. Working temperature from -30 °C up to +105 °C.  
Hose fittings with special O-rings (Viton or EPDM) available on request. For O-ring dimensions and part-numbers see Section Eb.

Approved **fitting series** for hose types:

26 201 206 213 221FR 285 293

# CF Female Metric 24° Light Series with O-Ring Swivel – 90° Elbow

ISO 12151-2-SWE-L – DKOL 90°

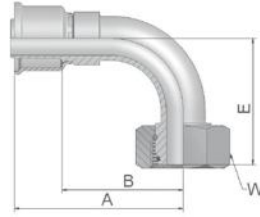

XXXXX-XX-XX Part Number 26	Hose I.D.			Thread metric	Tube O.D. mm	A mm	B mm	E mm	W mm
	Inch	Size	mm						
1CF26-8-4	3/16	-4	5.0	M14x1.5	8	48	28	29	17
1CF26-10-5	1/4	-5	6.3	M16x1.5	10	55	36	29	19
1CF26-10-6	5/16	-6	8.0	M16x1.5	10	55	34	31	19
1CF26-12-6	5/16	-6	8.0	M18x1.5	12	56	35	35	22
1CF26-12-8	13/32	-8	10.0	M18x1.5	12	51	30	31	22
1CF26-15-8	13/32	-8	10.0	M22x1.5	15	58	38	41	27
1CF26-18-10	1/2	-10	12.5	M26x1.5	18	57	34	38	32
1CF26-18-12	5/8	-12	16.0	M26x1.5	18	69	46	45	32
1CF26-22-12	5/8	-12	16.0	M30x2	22	78	55	47	36
1CF26-18-16	7/8	-16	22.0	M26x1.5	18	92	65	70	32
1CF26-28-16	7/8	-16	22.0	M36x2	28	95	68	71	41
1CF26-28-20	1-1/8	-20	29.0	M36x2	28	117	90	81	41
1CF26-35-20	1-1/8	-20	29.0	M45x2	35	117	90	77	50
1CF26-35-24	1-3/8	-24	35.0	M45x2	35	117	89	79	50

Hose fittings are delivered with ozone resistant Nitrile (NBR) O-ring as a standard version. Working temperature from -30 °C up to +105 °C.  
Hose fittings with special O-rings (Viton or EPDM) available on request. For O-ring dimensions and part-numbers see Section Eb.

# 49 Metric Banjo Straight

DIN 7642

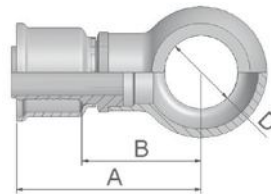

XXXXX-XX-XX Part Number 26	Hose I.D.			A mm	B mm	D mm
	Inch	Size	mm			
14926-12-6	5/16	-6	8.0	47	26	12
14926-14-6	5/16	-6	8.0	49	28	14
14926-14-8	13/32	-8	10.0	48	28	14
14926-16-8	13/32	-8	10.0	50	30	16
14926-33.4-20	1-1/8	-20	29.0	75	48	33

Approved fitting series for hose types:

26 201 206 213 221FR 285 293

## 92 Female BSP Parallel Pipe Swivel – Straight (60° Cone)

BS5200-A – DKR

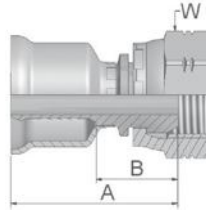

XXXXX-XX-XX Part Number 26	Hose I.D.			Thread BSP	A mm	B mm	W mm
	Inch	Size	mm				
19226-4-4	3/16	-4	5.0	1/4x19	41	20	19
19226-6-6	5/16	-6	8.0	3/8x19	42	21	22
19226-6-8	13/32	-8	10.0	3/8x19	41	21	22
19226-8-8	13/32	-8	10.0	1/2x14	44	23	27
19226-8-10	1/2	-10	12.5	1/2x14	45	22	27
19226-12-12	5/8	-12	16.0	3/4x14	45	24	32
19226-16-16	7/8	-16	22.0	1x11	52	25	41
19226-20-20	1-1/8	-20	29.0	1-1/4x11	58	31	50

## B1 Female BSP Parallel Pipe Swivel 45° Elbow (60° Cone)

BS 5200-D – DKR 45°

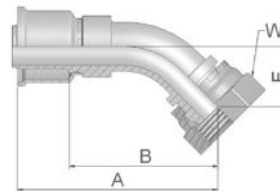

XXXXX-XX-XX Part Number 26	Hose I.D.			Thread BSP	A mm	B mm	E mm	W mm
	Inch	Size	mm					
1B126-4-4	3/16	-4	5.0	1/4x19	53	33	15	19
1B126-6-6	5/16	-6	8.0	3/8x19	56	36	16	22
1B126-8-8	13/32	-8	10.0	1/2x14	62	42	16	27
1B126-10-10	1/2	-10	12.5	5/8x14	67	44	20	30
1B126-12-12	5/8	-12	16.0	3/4x14	70	47	18	32

Approved **fitting series** for hose types:

26 201 206 213 221FR 285 293

## B2 Female BSP Parallel Pipe Swivel 90° Elbow (60° Cone)

BS 5200-B – DKR 90°

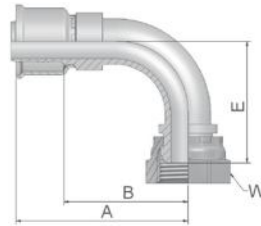

XXXXX-XX-XX Part Number 26	Hose I.D.			Thread BSP	A mm	B mm	E mm	W mm
	Inch	Size	mm					
1B226-4-4	3/16	-4	5.0	1/4x19	44	24	26	19
1B226-6-6	5/16	-6	8.0	3/8x19	47	26	29	22
1B226-8-8	13/32	-8	10.0	1/2x14	54	34	31	27
1B226-10-10	1/2	-10	12.5	5/8x14	57	34	36	30
1B226-12-12	5/8	-12	16.0	3/4x14	62	40	37	32
1B226-16-16	7/8	-16	22.0	1x11	96	69	67	41
1B226-20-20	1-1/8	-20	29.0	1-1/4x11	117	90	76	50

## 91 Male BSP Taper Pipe – Rigid Straight

BS5200 – AGR-K

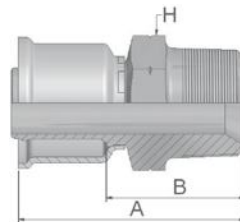

XXXXX-XX-XX Part Number 26	Hose I.D.			Thread BSP	A mm	B mm	H mm
	Inch	Size	mm				
19126-6-6	5/16	-6	8.0	3/8x19	47	26	19
19126-8-8	13/32	-8	10.0	1/2x14	53	32	22
19126-12-12	5/8	-12	16.0	3/4x14	58	36	30
19126-16-16	7/8	-16	22.0	1x11	69	43	36

Approved **fitting series** for hose types:

26 201 206 213 221FR 285 293



# 01

## Male NPTF Pipe Rigid – Straight

SAE J476A / J516 – AGN

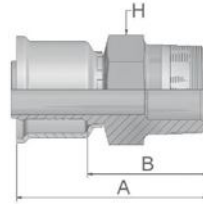

XXXXX-XX-XX Part Number 26	Hose I.D.			Thread NPTF	A mm	B mm	H Inch
	Inch	Size	mm				
10126-4-4	3/16	-4	5.0	1/4x18	48	26	9/16
10126-4-5	1/4	-5	6.3	1/4x18	48	26	9/16
10126-4-6	5/16	-6	8.0	1/4x18	48	26	3/4
10126-6-6	5/16	-6	8.0	3/8x18	48	26	11/16
10126-6-8	13/32	-8	10.0	3/8x18	48	26	11/16
10126-8-8	13/32	-8	10.0	1/2x14	54	33	7/8
10126-8-10	1/2	-10	12.5	1/2x14	57	33	7/8
10126-12-12	5/8	-12	16.0	3/4x14	59	35	1-1/16

# 06/68

## Female – JIC 37° SAE 45° Dual Flare Swivel – Straight

ISO12151-5-SWS – DKJ

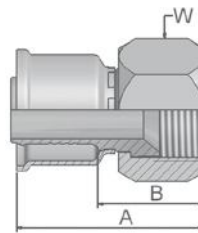

XXXXX-XX-XX Part Number 26	Hose I.D.			Thread UNF	Tube size Inch	A mm	B mm	W mm Inch
	Inch	Size	mm					
16826-4-4-SM	3/16	-4	5.0	7/16x20	1/4	43	24	14
16826-5-5-SM	1/4	-5	6.3	1/2x20	5/16	44	23	17
16826-5-5BA	1/4	-5	6.3	1/2x20	5/16	45	23	5/8
10626-6-6-SM	5/16	-6	8.0	9/16x18	3/8	45	24	19
10626-6-6	5/16	-6	8.0	9/16x18	3/8	45	23	11/16
16826-8-8-SM	13/32	-8	10.0	3/4x16	1/2	48	27	22
16826-8-10	1/2	-10	12.5	3/4x16	1/2	60	36	7/8
16826-10-10-SM	1/2	-10	12.5	7/8x14	5/8	41	19	27
16826-10-10BA	1/2	-10	12.5	7/8x14	5/8	55	31	1
16826-10-12-SM	5/8	-12	16.0	7/8x14	5/8	61	33	27
16826-10-12	5/8	-12	16.0	7/8x14	5/8	61	37	1
10626-12-12-SM	5/8	-12	16.0	1-1/16x12	3/4	56	34	32
10626-16-16-SM	7/8	-16	22.0	1-5/16x12	1	62	35	41
10626-20-20-SM	1-1/8	-20	29.0	1-5/8x12	1-1/4	66	39	50
10626-24-24-SM	1-3/8	-24	35.0	1-7/8x12	1-1/2	71	44	60
10626-32-32	1-13/16	-32	46.0	2-1/2x12	2	84	52	2-7/8

Approved fitting series for hose types:

BA: Nipple: Brass, Nut and Shell: Steel; SM: Metric Hexagon

26 201 206 213 221FR 285 293

# 08 Female SAE 45° – Swivel Straight

SAE J516

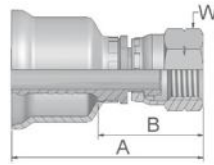

XXXXX-XX-XX Part Number 26	Hose I.D.		mm	Thread UNF	Tube size Inch	A mm	B mm	W Inch
	Inch	Size						
10826-6-6	5/16	-6	8.0	5/8x18	3/8	47	25	3/4
10826-6-6BA	5/16	-6	8.0	5/8x18	3/8	47	25	3/4
10826-12-12	5/8	-12	16.0	1-1/16x14	3/4	56	32	1-1/4

# 37/3V Female JIC 37° SAE 45° – Dual Flare Swivel Female 45° Elbow

ISO 12151-5-SWE 45° – DKJ 45°

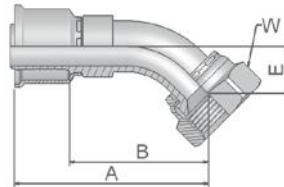

XXXXX-XX-XX Part Number 26	Hose I.D.		mm	Thread UNF	Tube size Inch	A mm	B mm	E mm	W mm Inch
	Inch	Size							
13V26-4-4-SM	3/16	-4	5.0	7/16x20	1/4	50	24	10	14
13726-6-6-SM	5/16	-6	8.0	9/16x18	3/8	54	33	11	19
13V26-8-8-SM	13/32	-8	10.0	3/4x16	1/2	59	38	15	22
13V26-10-10	1/2	-10	12.5	7/8x14	5/8	69	44	17	1
13726-12-12-SM	5/8	-12	16.0	1-1/16x12	3/4	75	53	20	32
13726-16-16-SM	7/8	-16	22.0	1-5/16x12	1	102	76	24	41

Approved fitting series for hose types:

BA: Nipple; Brass, Nut and Shell: Steel; SM: Metric Hexagon

26 201 206 213 221FR 285 293

**39/3W Female JIC 37°  
SAE 45° – Dual Flare  
Swivel Female 90° Elbow**

ISO 12151-5-SWES – DKJ 90°

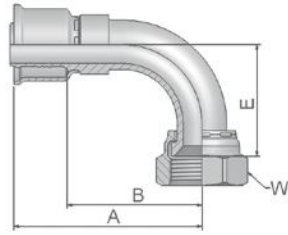

XXXXX-XX-XX Part Number 26	Hose I.D.		mm	Thread UNF	Tube size Inch	A mm	B mm	E mm	W mm
	Inch	Size							
13W26-4-4-SM	3/16	-4	5.0	7/16x20	1/4	45	20	21	14
13W26-5-5-SM	1/4	-5	6.3	1/2x20	5/16	50	30	20	17
13926-6-6-SM	5/16	-6	8.0	9/16x18	3/8	49	29	22	19
13W26-8-6-SM	5/16	-6	8.0	3/4x16	3/8	53	32	29	22
13W26-8-8-SM	13/32	-8	10.0	3/4x16	1/2	53	32	29	22
13W26-8-10-SM	1/2	-10	12.5	3/4x16	5/8	56	34	29	22
13W26-10-10-SM	1/2	-10	12.5	7/8x14	5/8	60	38	32	27
13W26-10-12-SM	5/8	-12	16.0	7/8x14	5/8	63	41	33	27
13926-12-12-SM	5/8	-12	16.0	1-1/16x12	3/4	73	51	46	32
13926-16-16-SM	7/8	-16	22.0	1-5/16x12	1	102	75	59	41
13926-20-20-SM	1-1/8	-20	29.0	1-5/8x12	1-1/4	109	81	70	50

Approved **fitting series** for hose types:

SM: Metric Hexagon

26 201 206 213 221FR 285 293

**JC**      **Female ORFS  
Swivel – Straight  
Short**

ISO 12151-1 – SWSA  
SAE J516 – ORFS

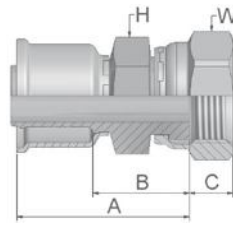

XXXXX-XX-XX Part Number	Hose I.D.			Thread UNF	A mm	B mm	C mm	H mm	W mm
	Inch	Size	mm						
26									
1JC26-4-4-SM	3/16	-4	5.0	9/16x18	42	20	8	14	17
1JC26-6-6-SM	5/16	-6	8.0	11/16x16	36	15	-	-	22
1JC26-8-6-SM	5/16	-6	8.0	13/16x16	44	23	-	19	24
1JC26-8-8-SM	13/32	-8	10.0	13/16x16	37	17	11	-	24
1JC26-10-10-SM	1/2	-10	12.5	1x14	49	27	12	24	30
1JC26-12-12-SM	5/8	-12	16.0	1-3/16x12	43	21	14	-	36
1JC26-16-16-SM	7/8	-16	22.0	1-7/16x12	61	34	14	36	41
1JC26-20-20-SM	1-1/8	-20	29.0	1-11/16x12	62	35	15	50	50

Approved **fitting series** for hose types:

SM: Metric Hexagon

26 201 206 213 221FR 285 293

## 5S Female Tube O-ring Swivel Short Pilot

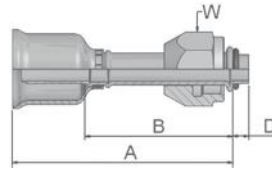

XXXXX-XX-XX Part Number 26				Thread UNF	A mm	B mm	D mm		W Inch
	Inch	Size	mm						
15S26-6-6	5/16	-6	8.0	5/8x18	66	44	4.7		3/4
15S26-8-8	13/32	-8	10.0	3/4x16	67	45	4.7		7/8
15S26-10-10	1/2	-10	12.5	7/8x14	71	47	4.7		1-1/16

## 5H Female Tube O-Ring Swivel 45° Elbow – Short Pilot

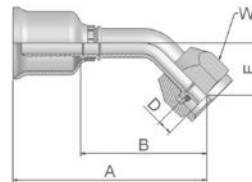

XXXXX-XX-XX Part Number 26				Thread UNF	A mm	B mm	D mm	E mm		W Inch
	Inch	Size	mm							
15H26-6-6	5/16	-6	8.0	5/8x18	61	39	4.7	14		3/4
15H26-10-10	1/2	-10	12.5	7/8x14	77	53	4.7	17		1-1/16

Approved **fitting series** for hose types:

26 285

## 5T Female Tube O-Ring Swivel 90° Elbow – Short Pilot

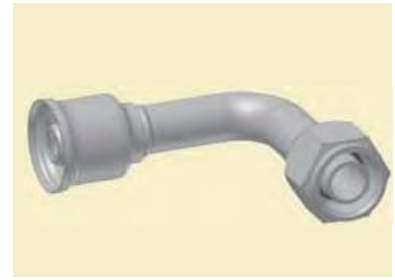
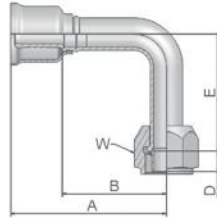

XXXXX-XX-XX Part Number 26				Thread UNF	A mm	B mm	D mm	E mm	 W Inch
	Inch	Size	mm						
15T26-6-6	5/16	-6	8.0	5/8x18	56	34	4.7	36	3/4
15T26-8-8	13/32	-8	10.0	3/4x16	63	41	4.7	37	7/8
15T26-10-10	1/2	-10	12.5	7/8x14	73	49	4.7	44	1-1/16

## 59PT Male Tube O-Ring Swivel Long Pilot

With Charge Port at 180° for R134a

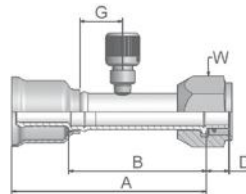

XXXXX-XX-XX Part Number 26				Thread UNF	A mm	B mm	D mm	G mm	 W Inch
	Inch	Size	mm						
15926-6-6-PT	5/16	-6	8.0	5/8x18	83	61	7.1	13	3/4
15926-8-8-PT	13/32	-8	10.0	3/4x16	74	52	9.8	13	7/8
15926-10-12-PT	5/8	-12	16.0	7/8x14	88	65	9.8	15	1-1/16

Approved **fitting series** for hose types:

26 285

# 5LPT Female Tube O-Ring Swivel 90° Elbow – Long Pilot

With Charge Port at 180° for R134a

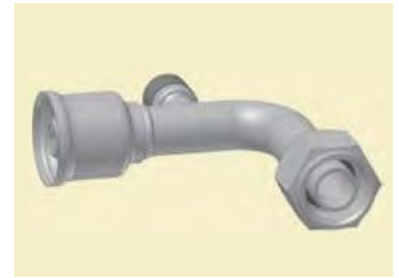
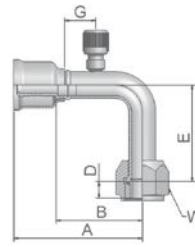

XXXXX-XX-XX Part Number 26					A mm	B mm	D mm	E mm	G mm	
	Inch	Size	mm	Thread UNF						W Inch
15L26-8-8-PT	13/32	-8	10.0	3/4x16	82	60	9.8	37	15	7/8
15L26-10-10-PT	1/2	-10	12.5	7/8x14	91	67	9.8	57	15	1-1/16
15L26-10-12-PT	5/8	-12	16.0	7/8x14	91	67	9.8	57	15	1-1/16

Approved **fitting series** for hose types:

26	285
----	-----

